



County Draperies, Inc.



Classic Collection 2015

# INDEX

## TRADITIONAL ENSEMBLES

ADJUSTABLE ROD KITS - 5/8" - 1/2" .....	25
ADJUSTABLE ROD KITS - 3/4" - 5/8" .....	26
ADJUSTABLE ROD KITS - 1" - 7/8" .....	27
ARTFIL KITS .....	22
BRASS 1" .....	33
BRASS 1 1/8" .....	34
BRASS 1 1/2" .....	35
CURVED RODS .....	25
METRO 1 1/8" .....	30
RIVER ROCKS 5/8" .....	23
SAN FRANCISCO PROGRAM - 5/8" DIAMETER ADJUSTABLE ROD KITS .....	25
SAN FRANCISCO PROGRAM - 3/4" DIAMETER ADJUSTABLE ROD KITS .....	26
SIMPLICITE .....	24
WROUGHT IRON 3/4" .....	28
WROUGHT IRON 1" .....	29
WROUGHT IRON 1 1/2" .....	31

## TEKNO ENSEMBLES

EURO-SCOPE .....	3
KONTUR ALU .....	5
KONTUR EVO .....	6
NEXGEN .....	12
NEXGEN WOOD .....	14
TEKNO 25 .....	4
TEKNO 40 .....	13
TEKNO 40 WOOD .....	10
URBAN 3 & 5 .....	8

## MEDALLIONS

INFINETTE INSTALLATIONS .....	32
-------------------------------	----

## TEKNO TRACK SYSTEM

PANELLO .....	16
---------------	----

## ACCESSORIES

WAVE DRAPE SYSTEM & KITS .....	18
--------------------------------	----

<b>TECHNICAL INFORMATION FOR TEKNO PRODUCTS .....</b>	<b>19 - 21</b>
---	----------------



**i** Wave Drape is available for **Euro-scope**.  
See page 18 for product codes and details.  
Euro-scope technical diagrams Page 19.

# EURO-SCOPE





**HAND DRAW**  
ENSEMBLE INCLUDES:  
RODDING, CLIC GLIDES, FLING WAND AND SUPPORTS.  
*EXTRA FLING WAND FOR CENTER OPENING DRAPES IS SOLD SEPARATELY.*



**ONE WAY - CORDED**  
ENSEMBLE INCLUDES:  
RODDING, CLIC GLIDES, PULLEY AND SUPPORTS.



**CENTER DRAW - CORDED**  
ENSEMBLE INCLUDES:  
RODDING, CLIC GLIDES, PULLEY AND SUPPORTS.

**i** Available with predetermined kits.

## SUPPORT STYLE

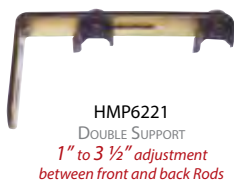

**Available colors**  
Rods & supports



**BR**  
BRONZE



**DA**  
DULL ARGENTO



**F**  
FOSSIL



**W**  
WHITE



**i** Rods longer than **106"** will be shipped in two equal lengths.  
One piece can be requested.  
Extra shipping charges apply.

Rod length	36"	48"	60"	72"	84"	96"	106"	120"	132"	144"	156"	168"	180"
Clic Glides	12	16	20	24	28	32	36	40	44	48	52	56	60
Supports	2	2	2	3	3	3	4	5	5	5	5	7	7
Splice	0	0	0	0	0	0	0	1	1	1	1	1	1

## OPTIONAL PRODUCTS

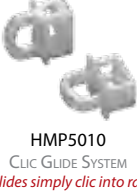

**HMP7360** - 36"  
**HMP7480** - 48"  
**HMP7600** - 60"  
ALUMINIUM FLING WANDS

**AVAILABLE COLORS:** BR, DA

## COMPATIBILITY

Rod Dimensions	DRAPES WITH : CLIC GLIDES				DRAPES WITH : STANDARD WAVE CARRIER				DRAPES WITH : STANDARD SNAP CARRIER			
	Hand Draw	One Way	Center	Tekno Carriers	Hand Draw	One Way	Center	Tekno Carriers	Hand Draw	One Way	Center	Tekno Carriers
48" - 72"	R	R	R	NR	R	R	R	NR	R	R	R	NR
84" - 96"	R	R	R	S	R	R	R	S	R	R	R	S
106"	R	R	R	S	R	R	R	S	R	R	R	S
120"	R	R	R	S	R	R	R	S	L	L	R	S
132"	L	L	R	S	L	L	R	S	L	L	L	S
144" - 156"	L	L	L	S	L	L	L	S	L	L	L	S
168" - 180"	NR	NR	L	S	NR	NR	NR	S	NA	NA	NA	S

█ RECOMMENDED 
 █ LIGHTWEIGHT DRAPES ONLY 
 █ SUGGESTED FOR HEAVY DRAPES 
 █ NOT RECOMMENDED 
 █ NOT AVAILABLE



**i** Wave Drape is available for Tekno 25. See page 18 for product codes and details. Tekno 25 technical diagrams Page 19.

# TEKNO 25 • 1 1/8" DIAMETER



## HAND DRAW

ENSEMBLE INCLUDES:  
RODDING, CLIC GLIDES, FLING WAND AND SUPPORTS.  
*EXTRA FLING WAND FOR CENTER OPENING*  
*DRAPES IS SOLD SEPARATELY.*

## ONE WAY - CORDED

ENSEMBLE INCLUDES:  
RODDING, CLIC GLIDES, PULLEY AND SUPPORTS.

## CENTER DRAW - CORDED

ENSEMBLE INCLUDES:  
RODDING, CLIC GLIDES, PULLEY AND SUPPORTS.

**i** Available with predetermined kits.

## SUPPORT STYLE

C-RINGS, SEE PAGE 11



## OPTIONAL PRODUCTS



EXTENDER POST 2" - HFP4027  
EXTENDER POST 4" - HFP4047  
*Extends Tekno wall supports*



TEKNO DOUBLE SUPPORT  
HTP6228 - 4" SUPPORT  
HTP6238 - 6" SUPPORT  
*Use with ROD ONLY ensembles*  
*C-Rings do not work with Double Support*



HFP6168  
LATERAL SUPPORT 28  
*Inside mount -*  
*deduct 1/4" from rod per bracket.*  
*Use with ROD ONLY ensembles up to 72"*



HTP6058  
TEKNO CEILING SUPPORT 2"  
*2 1/8" drop from ceiling to rod*  
*Use with ROD ONLY ensembles*



HTP6068  
TEKNO CEILING SUPPORT 4"  
*4 1/8" drop from ceiling to rod*  
*Use with ROD ONLY ensembles*

**i** Rods longer than 106" will be shipped in two equal lengths. One piece can be requested. Extra shipping charges apply.

Rod length	36"	48"	60"	72"	84"	96"	106"	120"	132"	144"	156"	168"	180"
Splice	0	0	0	0	0	0	0	1	1	1	1	1	1

**i** Available colors for finials are identified in RED TEXT.

## FINIALS

HFP0048  
3 3/8" L x 2 1/8" DIA.  
*Shown in Antique*  
A, AS, CH, DW, MR, RS



BALL 28

HFP0188  
1" L x 1 3/8" DIA.  
*Shown in Champagne*  
A, AS, CH, DW, MR, RS



BARO 28



CAPUCHON 28



EMPIRE

HAP0318  
4" L x 2 3/4" DIA.  
*Shown in Distressed Wood*  
A, DW, P, RS



EXCENTRIX



LINEA

HAP0468  
2 1/8" L x 2 1/8" DIA.  
*Shown in Maroon*  
A, AS, CH, DW, MR, RS



OVAL 28



TRANS LU

HAP0328  
4 1/4" L x 2 3/8" DIA.  
*Shown in Pewter*  
A, DW, P, RS



HAP0328

HFP0548  
7/8" L x 1 5/8" DIA.  
*Shown in Antique Silver*  
A, AS, CH, DW, MR, RS



HFP0548

HFP0568  
4" L x 2 1/8" DIA.  
*Shown in Antique Silver*  
A, AS, CH, DW, MR, RS



HFP0568

HFP0538  
4" L x 2 1/8" DIA.  
*Shown in Champagne*  
A, AS, CH, DW, MR, RS



HFP0538

**Available colors**  
Rods, supports & finials

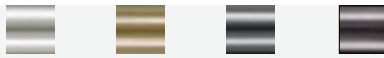

AS ANTIQUE SILVER CH CHAMPAGNE DW DISTRESSED WOOD MR MAROON

**Available colors**  
Certain finials only

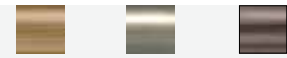

A ANTIQUE P PEWTER RS RUSSETTE

**i** Wave Drape is available for Kontur ALU. See page 18 for product codes and details. Kontur ALU technical diagrams Page 19.

# KONTUR ALU



## HAND DRAW

ENSEMBLE INCLUDES:  
RODDING, CLIC GLIDES, FLING WAND AND SUPPORTS.  
*EXTRA FLING WAND FOR CENTER OPENING DRAPES IS SOLD SEPARATELY.*

## ONE WAY - CORDED

ENSEMBLE INCLUDES:  
RODDING, CLIC GLIDES, PULLEY AND SUPPORTS.

## CENTER DRAW - CORDED

ENSEMBLE INCLUDES:  
RODDING, CLIC GLIDES, PULLEY AND SUPPORTS.

**i** Available with predetermined kits.

## SUPPORT STYLE



HTP6010  
KONTUR CEILING SUPPORT



HTP6020  
KONTUR SUPPORT 2"



HTP6040  
KONTUR SUPPORT 4"

AVAILABLE COLORS: AS, CH, DW

OUVERTURE FINIAL -  
DRAPE BUTTS TO WALL ELIMINATING  
LIGHT GAPS

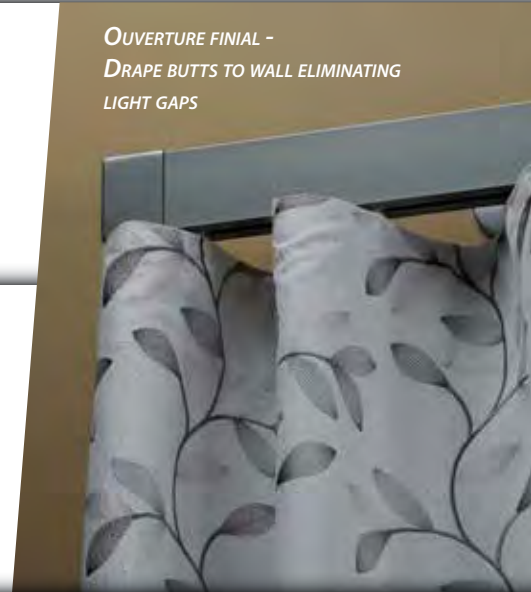

## OPTIONAL PRODUCTS

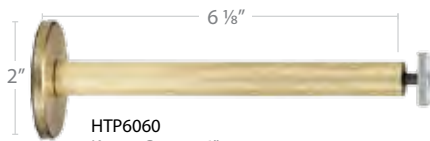

HTP6060  
KONTUR SUPPORT 6"



HFP4027 - EXTENDER POST 2"  
HFP4047 - EXTENDER POST 4"  
*Extends Tekno wall supports*

## FINIALS



HTP0010  
KONTUR ENDCAP



HTP0040  
OUVERTURE  
*Sold in pairs*



HTP0050  
SEPARATE  
*Sold in pairs*

## RETURNS

QUADRA  
HTP0092 - QUADRA 2  
HTP0094 - QUADRA 4  
HTP0096 - QUADRA 6  
*Return determined by size of support;  
Kontur Support 2", 4" & 6"  
Each return adds 1/4" to rod length.*



ALU RETURN  
HTP0082 - ALU RETURN 2  
HTP0084 - ALU RETURN 4  
HTP0086 - ALU RETURN 6  
*Return determined by size of support;  
Kontur Support 2", 4" & 6"  
Each return adds 1" to rod length.*



Available colors  
Rods, supports & finials



AS  
ANTIQUE SILVER

DW  
DISTRESSED WOOD

OB  
OIL RUBBED BRONZE

TA  
TAUPE



Wave Drape is available for **Kontur EVO**.  
See page 18 for product codes and details.  
Kontur EVO technical diagrams Page 19.

# KONTUR EVO



## HAND DRAW

ENSEMBLE INCLUDES:  
RODDING, CLIC GLIDES, FLING WAND AND SUPPORTS.  
*EXTRA FLING WAND FOR CENTER OPENING  
DRAPES IS SOLD SEPARATELY.*

## ONE WAY - CORDED

ENSEMBLE INCLUDES:  
RODDING, CLIC GLIDES, PULLEY AND SUPPORTS.

## CENTER DRAW - CORDED

ENSEMBLE INCLUDES:  
RODDING, CLIC GLIDES, PULLEY AND SUPPORTS.



Available with predetermined kits.

## SUPPORT STYLE



AVAILABLE COLORS: AS, CH, DW

## OPTIONAL PRODUCTS

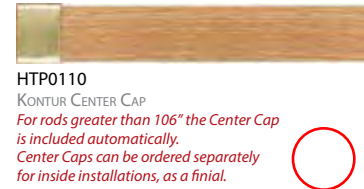

Rods longer than **106"** will be shipped in two equal lengths.  
One piece can be requested.  
Extra shipping charges apply.

Rod length	36"	48"	60"	72"	84"	96"	106"	120"	132"	144"	156"
Hand Draw Splice	0	0	0	0	0	0	0	*1	*1	*1	*1
One Way Splice	0	0	0	0	0	0	0	N/A	N/A	N/A	N/A
Center Draw Splice	0	0	0	0	0	0	0	1	1	1	1

*\*HAND DRAWN RODS, WHICH ARE SHIPPED IN TWO PIECES, CAN ONLY BE USED AS A CENTER OPENING.*

## ROD COLORS



BW  
BARN WOOD

CM  
CHERRY

E  
EBONY

I  
IVORY

SM  
SMOKE

TR  
TRUFFLE

WE  
WENGE

## FINIALS

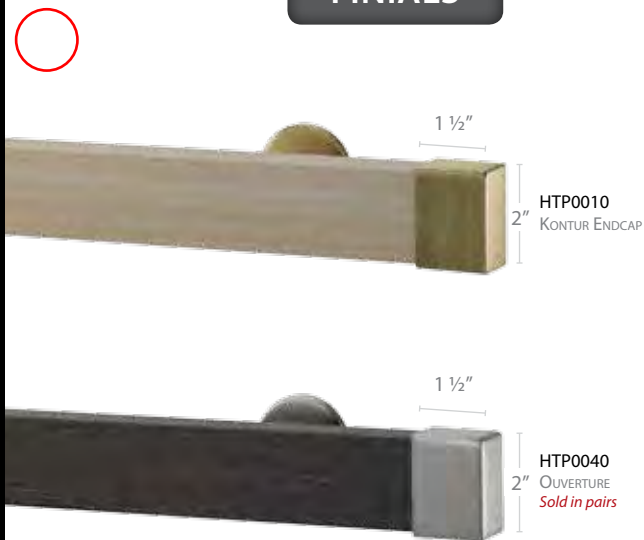

SHOWN WITH OUVERTURE FINIAL



## RETURNS



QUADRA  
HTP0092 - QUADRA 2  
HTP0094 - QUADRA 4  
HTP0096 - QUADRA 6  
*Return determined by size of support;  
Kontur Support 2", 4" & 6"  
Each return adds 1/4" to rod length.*

AVAILABLE COLORS: AS, DW



HTP0120  
REVERSE CORNER  
*Sold as ensembles with choice of support.  
See price-list for ordering instructions.*

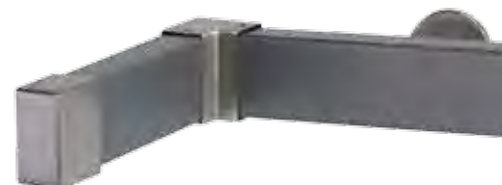

KONTUR RETURN  
HTP0112 - KONTUR RETURN 2  
HTP0114 - KONTUR RETURN 4  
HTP0116 - KONTUR RETURN 6  
*Return determined by size of support;  
Kontur Support 2", 4" & 6"  
Each return adds 1" to rod length.*

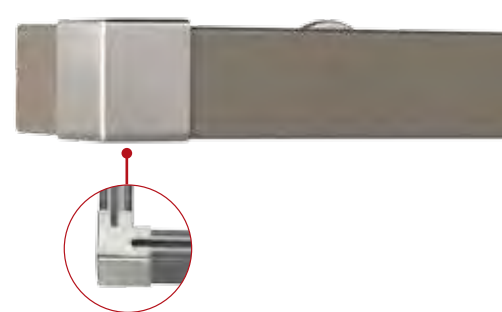

Available colors  
Finials & returns



A  
ANTIQUE



CR  
CHROME



S  
STAINLESS

Available colors  
Quadra returns



AS  
ANTIQUE SILVER



DW  
DISTRESSED WOOD



Wave Drape is available for Urban 3 & 5.  
See page 18 for product codes and details.  
Urban 3 & 5 technical diagrams Page 20.

# URBAN 3 & URBAN 5



## VALANCE ONLY

ENSEMBLE INCLUDES:  
VALANCE, 2 RETURNS, & SUPPORTS  
*CEILING SUPPORTS SOLD SEPARATELY.*

## HAND DRAW

ENSEMBLE INCLUDES:  
VALANCE, RETURNS, CLIC GLIDES, FLING WAND & SUPPORTS.  
*CEILING SUPPORTS SOLD SEPARATELY.*  
*EXTRA FLING WAND FOR CENTER OPENING DRAPES IS SOLD SEPARATELY.*

## CORDED SYSTEMS

ENSEMBLE INCLUDES:  
VALANCE, RETURNS, CLIC GLIDES, PULLEY & SUPPORTS.  
*CEILING SUPPORTS SOLD SEPARATELY.*

## VALANCE ENSEMBLES



### URBAN 5 WITH RETURN 3

SHOWN IN DULL ARGENTO (DA)

RETURN SIZE: 3" LENGTH X 5" HEIGHT X 1/4" WIDTH



HUP6030  
SUPPORT U-3  
2 1/4" interior  
projection, from  
wall to valance.

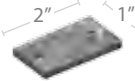

HUP6080  
URBAN CEILING SUPPORT  
*Available with all kits.*



### URBAN 3 WITH RETURN 3

SHOWN IN BLACK (DW)

RETURN SIZE:  
3" LENGTH X 3" HEIGHT X 1/4" WIDTH



### URBAN 5 WITH RETURN 5.5

SHOWN IN DULL ARGENTO (DA)

RETURN SIZE: 5 1/2" LENGTH X 5" HEIGHT X 1/4" WIDTH



HUP6050  
SUPPORT U-5.5  
5 7/8" interior  
projection, from  
wall to valance.

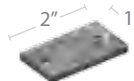

HUP6080  
URBAN CEILING SUPPORT  
*Available with all kits.*



### URBAN 3 WITH RETURN 5.5

SHOWN IN BLACK (DW)

RETURN SIZE:  
5 1/2" LENGTH X 3" HEIGHT X 1/4" WIDTH



### URBAN 5 WITH RETURN 7.5

SHOWN IN DULL ARGENTO (DA)

RETURN SIZE: 7 1/2" LENGTH X 5" HEIGHT X 1/4" WIDTH



HUP6070  
SUPPORT U-7.5  
6 7/8" interior  
projection, from  
wall to valance.

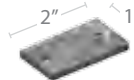

HUP6080  
URBAN CEILING SUPPORT  
*Available with all kits.*



### URBAN 3 WITH RETURN 7.5

SHOWN IN BLACK (DW)

RETURN SIZE:  
7 1/2" LENGTH X 3" HEIGHT X 1/4" WIDTH



Valance and returns are  
available in two colors: DA, DW



### Available colors

Valance: complete list below  
Returns: DA, DW

## COLORS

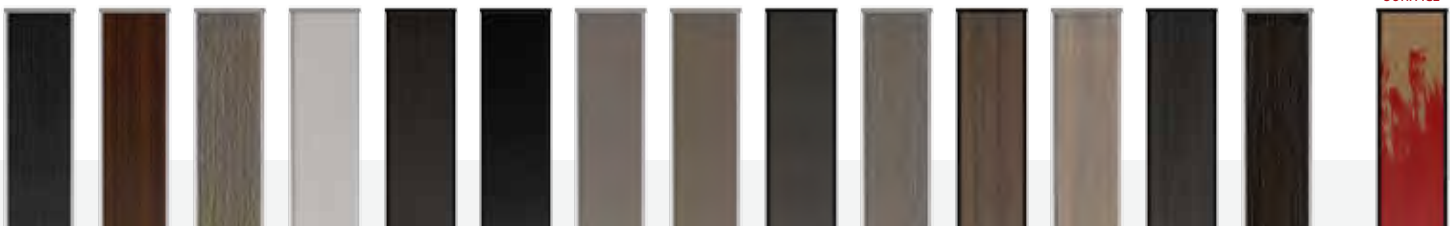

AH

ASH

AU

AUTUMN

BD

BEACHWOOD

BC

BÉCHAMEL

CF

CAFÉ

CB

CARBON

DT

DELTA

DU

DUNE

GR

GRAPHITE

LT

LATITUDE

MY

MYSTIQUE

RV

RIVA

SV

SILVA

TB

TIMBER

CV

CANVAS



# URBAN COMBINATIONS



SINGLE WAVE - VALANCE ROD



SINGLE WAVE - VALANCE

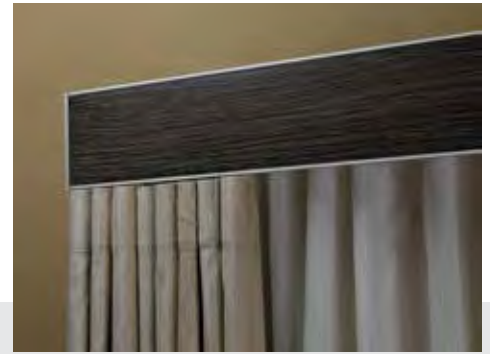

DOUBLE WAVE



SINGLE PLEATED DRAPE - VALANCE ROD



SINGLE PLEATED DRAPE - VALANCE

WHEN USING URBAN 3, ENSURE PLEATS DO NOT EXTEND BELOW VALANCE.



DOUBLE PLEATED DRAPE



SINGLE SHADE - VALANCE



SHADE + WAVE



SHADE + PLEATED DRAPE

## COMPATIBILITY

CONFIGURATIONS	SPECIAL REQUIREMENTS	3" RETURN	5.5" RETURN	7.5" RETURN	CEILING SUPPORT (For all Return lengths)
Single Wave - valance rod	None	Yes	Yes	Best w/ 3 or 5.5" Re.	Yes
Single Wave - valance	Euro/Nexgen Rods	No	Yes	Best w/ 5.5" Return	Yes
Single Pleated Drape - valance rod	None	Yes	Yes	Best w/ 3 or 5.5" Re.	Yes
Single Pleated Drape - valance	Euro/Nexgen Rods	Yes	Yes	Best w/ 3 or 5.5" Re.	Yes
Single Shade Product - valance	1.75" Clearance	Yes (1.75" Clearance)	Yes	Best w/ 5.5" Return	Yes
Double Wave	Euro/Nexgen Rods	No	No	Yes	Yes
Double Pleated Drape	Euro/Nexgen Rods	No	Yes	Best w/ 5.5" Return	Yes
Shade + Wave Product	Verify supports	Yes (1.75" Clearance)	Yes	Best w/ 5.5" Return	Yes
Shade + Pleated Drape	Verify supports	Yes (1.75" Clearance)	Yes	Best w/ 5.5" Return	Yes

**i** Wave Drape is available for Tekno 40 Wood. See page 18 for product codes and details. Tekno 40 Wood technical diagrams Page 20.

# TEKNO 40 WOOD • 1 1/2" DIAMETER



## HAND DRAW

ENSEMBLE INCLUDES: RODDING, CLIC GLIDES, FLING WAND AND SUPPORTS.  
*EXTRA FLING WAND FOR CENTER OPENING DRAPES IS SOLD SEPARATELY.*



## ONE WAY - CORDED

ENSEMBLE INCLUDES: RODDING, CLIC GLIDES, PULLEY AND SUPPORTS.



## CENTER DRAW - CORDED

ENSEMBLE INCLUDES: RODDING, CLIC GLIDES, PULLEY AND SUPPORTS.

**i** Available with predetermined kits.

## SUPPORT STYLE



## OPTIONAL PRODUCTS



HTP6164  
LATERAL SUPPORT 40  
Inside mount - deduct 1/4" from rod per bracket. Use with ROD ONLY ensembles up to 72"



HTP6014  
T40 CEILING SUPPORT  
Use with ROD ONLY ensembles



HFP4027S - EXTENDER POST 2"  
HFP4047S - EXTENDER POST 4"  
Extends Tekno wall supports

**i** Rods longer than 106" will be shipped in two equal lengths. One piece can be requested. Extra shipping charges apply.

Rod length	36"	48"	60"	72"	84"	96"	106"	120"	132"	144"	156"
Hand Draw Splice	0	0	0	0	0	0	0	*1	*1	*1	*1
One Way Splice	0	0	0	0	0	0	0	N/A	N/A	N/A	N/A
Center Draw Splice	0	0	0	0	0	0	0	1	1	1	1

\*HAND DRAWN RODS WHICH ARE SHIPPED IN TWO PIECES, CAN ONLY BE USED AS A CENTER OPENING.

## ROD & FINIAL COLORS



HTP0014  
TEKNO 40 ENDCAP  
1/2" length x 1 3/8" diameter

AVAILABLE COLORS: A, CR, S

## TORRIFIED WOOD

BRINGING AN AROMATIC FOREST INTO YOUR HOME  
CHEMICAL FREE, RICH COLORS & A NATURAL WOOD SMELL  
NATURAL KNOTS AND COLOR VARIATIONS MAY APPEAR.



BW  
BARN WOOD



E  
EBONY



FG  
FUDGE



I  
IVORY



SM  
SMOKE



TR  
TRUFFLE



T40  
TORRIFIED 40



T80  
TORRIFIED 80

# SHARED COMPONENTS • TEKNO 25, KONTUR ALU/EVO, URBAN, TEKNO 40 WOOD

**i** Wave Drape is available for Tekno 25, Kontur ALU/EVO, Urban & Tekno 40 Wood. See page 18 for product codes and details.



**HMP5340**  
TEKNO CARRIER  
See chart below for when to use



**HMP7020**  
END STOP CLIC  
Adjustable end stop blocks glides at any position on rail



**HMP5010**  
CLIC GLIDE SYSTEM  
Glides simply clic into rail



**HTP5010**  
C-RING  
Cannot be used with Tekno Double Support

AVAILABLE COLORS:  
A, AS, CH, DW, MR, S



**HMP7360 - 36"**  
**HMP7480 - 48"**  
**HMP7600 - 60"**  
ALUMINIUM FLING WANDS

AVAILABLE COLORS: BR, DA



**HFP7100 - 39"**  
FUSION FLING WAND

AVAILABLE COLORS: A, F, P, RS



Rod length	36"	48"	60"	72"	84"	96"	106"	120"	132"	144"	156"	168"	180"
Clic Glides	12	16	20	24	28	32	36	40	44	48	52	56	60
C-Rings	12	16	20	24	28	32	36	40	44	48	52	56	60
Supports	2	2	2	3	3	3	4	5	5	5	5	7	7

**i** Rods longer than **106"** will be shipped in two equal lengths. One piece can be requested. Extra shipping charges apply.

**i** Technical diagrams for Euro-scope Upgrade **page 21**.

## EURO-SCOPE UPGRADE



EURO-SCOPE UPGRADE

ENSEMBLE INCLUDES:

RODDING, CARRIERS AND ALL NECESSARY MOUNTING HARDWARE.

*Euro-Scope rod hangs below front rod.*

*Make Euro-scope drape a minimum of 3/4" shorter than front drape.*

AVAILABLE COLORS: BR, DA, F, W



**i** Tekno Carriers are **\*NOT COMPATIBLE** with Kontur EVO.

## COMPATIBILITY

Rod Dimensions	DRAPES WITH : CLIC GLIDES				DRAPES WITH : STANDARD WAVE CARRIER				DRAPES WITH : STANDARD SNAP CARRIER			
	Hand Draw	One Way	Center	*Tekno Carriers	Hand Draw	One Way	Center	*Tekno Carriers	Hand Draw	One Way	Center	*Tekno Carriers
48" - 72"	R	R	R	NR	R	R	R	NR	R	R	R	NR
84" - 96"	R	R	R	S	R	R	R	S	R	R	R	S
106"	R	R	R	S	R	R	R	S	R	R	R	S
120"	R	R	R	S	R	R	R	S	L	L	R	S
132"	L	L	R	S	L	L	R	S	L	L	L	S
144" - 156"	L	L	L	S	L	L	L	S	L	L	L	S
168" - 180"	NR	NR	L	S	NR	NR	NR	S	NA	NA	NA	S

RECOMMENDED LIGHTWEIGHT DRAPES ONLY SUGGESTED FOR HEAVY DRAPES NOT RECOMMENDED NOT AVAILABLE

**i** Wave Drape is available for Nexgen. See page 18 for product codes and details. Nexgen technical diagrams Page 21.

# NEXGEN



## HAND DRAW

ENSEMBLE INCLUDES:  
RODDING, NEXGEN GLIDES, FLING WAND AND SUPPORTS.  
*EXTRA FLING WAND FOR CENTER OPENING*  
*DRAPES IS SOLD SEPARATELY.*

## ONE WAY - CORDED

ENSEMBLE INCLUDES:  
RODDING, NEXGEN GLIDES, PULLEY AND SUPPORTS.

## CENTER DRAW - CORDED

ENSEMBLE INCLUDES:  
RODDING, NEXGEN GLIDES, PULLEY AND SUPPORTS.

**i** Available with predetermined kits.

## SUPPORT STYLE



## OPTIONAL PRODUCTS

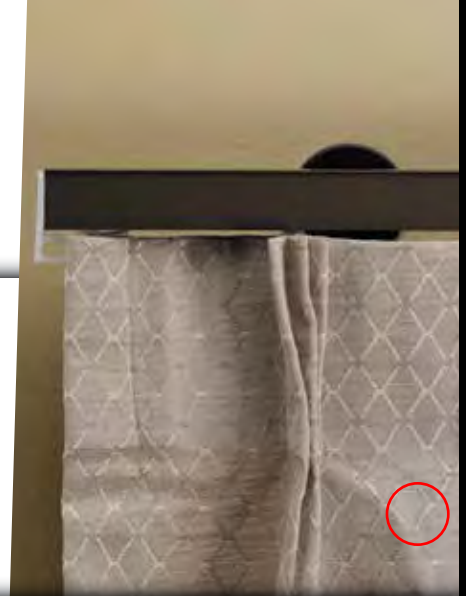

**i** Rods longer than 106" will be shipped in two equal lengths. One piece can be requested. Extra shipping charges apply.

Rod length	36"	48"	60"	72"	84"	96"	106"	120"	132"	144"	156"	168"	180"
Splice	0	0	0	0	0	0	0	1	1	1	1	1	1

## OPTIONAL ENDCAP



**Available colors**  
Rods, supports & endcap



BR  
BRONZE

DA  
DULL ARGENTO

W  
WHITE

## DOUBLE ROD

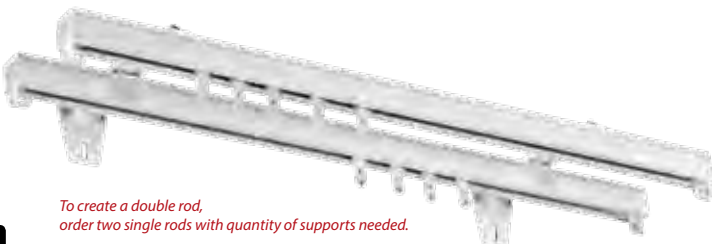

**i** Wave Drape is available for Tekno 40. See page 18 for product codes and details. Tekno 40 technical diagrams Page 21.

# TEKNO 40 • 1 1/2" DIAMETER

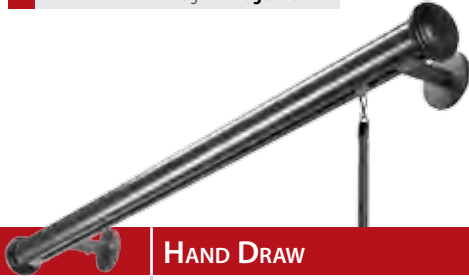

## HAND DRAW

ENSEMBLE INCLUDES:  
RODDING, NEXGEN GLIDES, FLING WAND AND SUPPORTS.  
*EXTRA FLING WAND FOR CENTER OPENING DRAPES IS SOLD SEPARATELY.*



## ONE WAY - CORDED

ENSEMBLE INCLUDES:  
RODDING, NEXGEN GLIDES, PULLEY AND SUPPORTS.



## CENTER DRAW - CORDED

ENSEMBLE INCLUDES:  
RODDING, NEXGEN GLIDES, PULLEY AND SUPPORTS.

**i** Available with predetermined kits.

## SUPPORT STYLE



## OPTIONAL PRODUCTS



EXTENDER POST 2" - HFP4027  
EXTENDER POST 4" - HFP4047  
*Extends Tekno wall supports*



AVAILABLE COLORS: AS, CH, DW



INSIDE MOUNT - DEDUCT 1/4" FROM ROD PER BRACKET. USE WITH ROD ONLY ENSEMBLES UP TO 72"



## FINIALS



**ARON**

HTP0204  
4" L x 2 3/8" DIA.  
*Shown in Sienna*



**CENTRALIA**

HTP0214  
3 5/8" L x 2 3/8" DIA.  
*Shown in Sandal*



**ELFIN**

HTP0284  
4" L x 2 3/4" DIA.  
*Shown in Maroon*



**GARIBALDI**

HTP0304  
3 3/4" L x 2 5/8" DIA.  
*Shown in Antique Silver*



**MELROSE**

HTP0274  
4 3/4" L x 3 1/8" DIA.  
*Shown in Antique Silver*



**TAMA 40**

HTP0294  
4 1/4" L x 2 7/8" DIA.  
*Shown in Distressed Wood*



**TAPPO 40**

HTP0264  
1/2" L x 2 1/8" DIA.  
*Shown in Sienna*



Available colors  
Rods, supports & finials



AS  
ANTIQUe SILVER



DW  
DISTRESSED WOOD



MR  
MAROON



SD  
SANDAL



SN  
SIENNA

**i** Wave Drape is available for Nexgen Wood. See page 18 for product codes and details. Nexgen Wood technical diagrams Page 21.

# NEXGEN WOOD • 2" DIAMETER

*COLOR FOR RAIL AND SUPPORTS WILL BE CHOSEN BY THE FACTORY. RAIL IS HIDDEN BEHIND THE DECORATIVE WOOD FACADE.*



## HAND DRAW

ENSEMBLE INCLUDES: RODDING, NEXGEN GLIDES, FLING WAND AND SUPPORTS.  
*EXTRA FLING WAND FOR CENTER OPENING*  
*DRAPES IS SOLD SEPARATELY.*

## ONE WAY - CORDED

ENSEMBLE INCLUDES: RODDING, NEXGEN GLIDES, PULLEY AND SUPPORTS.

## CENTER DRAW - CORDED

ENSEMBLE INCLUDES: RODDING, NEXGEN GLIDES, PULLEY AND SUPPORTS.

## SUPPORT STYLE

**i** Available with predetermined kits.



## OPTIONAL PRODUCTS



EXTENDER POST 2" - HFP4027  
EXTENDER POST 4" - HFP4047  
*Extends Tekno wall supports*



## FINIALS



### ANTIKA

HTP0026  
5 1/2" L X 3 7/8" DIA.  
*Shown in Sandal*



### DHARMA

HTP0036  
4" L X 3 3/4" DIA.  
*Shown in Gold*



### TAPPO 50

HTP0016  
1" L X 2 3/4" DIA.  
*Shown in Distressed Wood*



### TREVI

HTP0046  
5 3/4" L X 4" DIA.  
*Shown in Antique Silver*

**Available colors**  
Finials

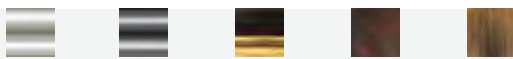

AS ANTIQUE SILVER   DW DISTRESSED WOOD   GL GOLD   MH MAHOGANY   SD SANDAL

**Available colors**  
Wood rods



DW DISTRESSED WOOD   WE WENGE   FG FUDGE   M MOCHA

# SHARED COMPONENTS • NEXGEN, TEKNO 40, NEXGEN WOOD

**i** Wave Drape is available for Nexgen, Tekno 40, Nexgen Wood. See page 18 for product codes and details.



HMP5020  
BALL BEARING CARRIER



HMP5011  
NEXGEN GLIDE

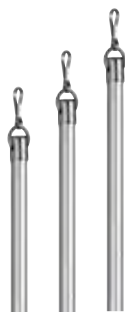

HMP7360 - 36"  
HMP7480 - 48"  
HMP7600 - 60"  
ALUMINIUM FLING WANDS

AVAILABLE COLORS: BR, DA



HFP7100 - 39"  
FUSION FLING WAND

AVAILABLE COLORS: A, F, P, RS

**i** Rods longer than 106" will be shipped in two equal lengths. One piece can be requested. Extra shipping charges apply.

Rod length	36"	48"	60"	72"	84"	96"	106"	120"	132"	144"	156"	168"	180"
Nexgen Glides	12	16	20	24	28	32	36	40	44	48	52	56	60
Supports	2	2	2	3	3	3	4	5	5	5	5	7	7
Splice	0	0	0	0	0	0	0	1	1	1	1	1	1

**i** Technical diagrams for Euro-scope Upgrade page 21.

## EURO-SCOPE UPGRADE



EURO-SCOPE UPGRADE

ENSEMBLE INCLUDES:

RODDING, CARRIERS AND ALL NECESSARY MOUNTING HARDWARE.

*Euro-Scope rod hangs below front rod.*

*Make Euro-scope drape a minimum of 3/4" shorter than front drape.*

AVAILABLE COLORS: BR, DA, F, W



STANDARD  
INSTALLATION

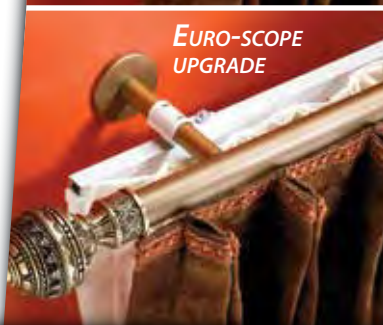

EURO-SCOPE  
UPGRADE



TEKNO 25 WITH  
EURO-SCOPE UPGRADE

## COMPATIBILITY

Rod Dimensions	DRAPES WITH : NEXGEN GLIDES				DRAPES WITH : STANDARD WAVE CARRIER				DRAPES WITH : STANDARD SNAP CARRIER			
	Hand Draw	One Way	Center	Tekno Carriers	Hand Draw	One Way	Center	Tekno Carriers	Hand Draw	One Way	Center	Tekno Carriers
48" - 72"	R	R	R	NR	R	R	R	NR	R	R	R	NR
84" - 96"	R	R	R	S	R	R	R	S	R	R	R	S
106"	R	R	R	S	R	R	R	S	R	R	R	S
120"	R	R	R	S	R	R	R	S	L	L	R	S
132"	L	L	R	S	L	L	R	S	L	L	L	S
144" - 156"	L	L	L	S	L	L	L	S	L	L	L	S
168" - 180"	NR	NR	L	S	NR	NR	NR	S	NA	NA	NA	S

RECOMMENDED LIGHTWEIGHT DRAPES ONLY SUGGESTED FOR HEAVY DRAPES NOT RECOMMENDED NOT AVAILABLE



Euro-Scope & Tekno 25 technical diagrams **Page 21.**  
Refer to **Double Support** installation.

# PANELLO • PANEL TRACKS

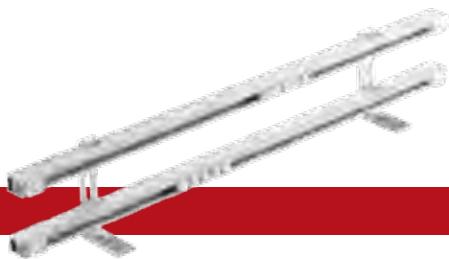

**EURO-SCOPE**



**TEKNO 25**



**Finial selection** will automatically include caps for back rod unless otherwise specified.

## TEKNO 25 FINIALS



**CAP 28**

HFP0058  
7/8" L x 1 3/8" DIA.  
*Shown in Antique Silver*



**BALL 28**

HFP0048  
3 3/8" L x 2 3/8" DIA.  
*Shown in Marron*



**OVAL 28**

HFP0468  
2 1/8" L x 2 1/8" DIA.  
*Shown in Champagne*



**Available colors**  
Euro-Scope rods



**BR**  
BRONZE



**DA**  
DULL ARGENTO



**W**  
WHITE



**Available colors**  
Tekno 25 finials & rods



**AS**  
ANTIQUE SILVER



**CH**  
CHAMPAGNE



**DW**  
DISTRESSED WOOD



**MR**  
MAROON

## OPTIONAL PRODUCTS

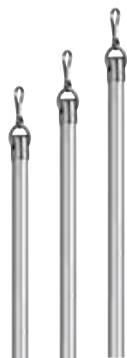

HMP7360 - 36"  
HMP7480 - 48"  
HMP7600 - 60"  
ALUMINIUM FLING WANDS



AVAILABLE COLORS: BR, DA





# PANELLO • PANEL TRACKS

To create your customized panel track system:

**1 Choose track width, 2 Choose panel width, 3 Choose quantity of panels** (Refer to price list for tabulation and codes.)



The flexibility of the dual-track panel system offers numerous stacking possibilities depending on changing sunlight conditions throughout the day. (It is not necessary to specify stacking preferences when ordering)

## PANEL GLIDERS

Panello Panel Tracks offer two ways to attach your fabric.

**Custom Panel Gliders & Hook and Loop Panel Gliders.**

- Custom Panel Gliders** allow your fabric to slide onto the hanger. Make the rod pocket a minimum of 1".
- Hook & Loop Panel Gliders** allow for quick placement and removal of fabric for cleaning.

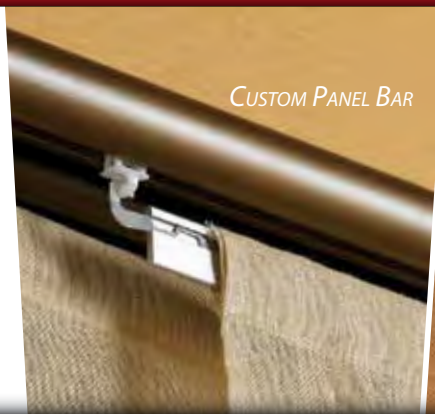

## STANDARD KITS

Standard kits are easy. Just add fabric!

COMES ONLY WITH A STANDARD PANEL BAR, 12" OR 24".

- Make the rod pocket minimum of 1".



## 12" PANEL-TRACK

ENSEMBLE INCLUDES:  
DUAL-TRACK RAIL SYSTEM, 2 CAPS FOR BACK ROD (AVAILABLE WITH TEKNO 25),  
MOUNTING RAIL SUPPORTS, PANEL BARS, BALLAST BOTTOM BARS, STANDARD 36" FLING WAND  
*FINIALS & EXTRA FLING WAND FOR CENTER OPENING DRAPES IS SOLD SEPARATELY.*

Track Width (Up To)	28" - 32"	42"	52"	62"	72"	84"	96"	102"
No. of Panels	3	4	5	6	7	8	9	10
No. of Supports	2	2	2	3	3	3	3	4
Splice	0	0	0	0	0	0	0	0
Panel Overlap	3" - 1"	4" - 1"	4" - 1"	3" - 1"	3" - 1"	3" - 1"	3" - 1"	2 1/2" - 1 1/2"
Stackback Width	14"	15"	16"	17"	18"	19"	20"	21"

- NUMBER OF INCHES EACH PANEL OVERLAPS ONTO THE NEXT, VARIES ACCORDING TO TRACK LENGTH AND NUMBER OF PANELS.
- WIDTH OF ALL PANELS WHEN COMPLETELY STACKED TOGETHER.



## 24" PANEL-TRACK

ENSEMBLE INCLUDES:  
DUAL-TRACK RAIL SYSTEM, 2 CAPS FOR BACK ROD (AVAILABLE WITH TEKNO 25),  
MOUNTING RAIL SUPPORTS, PANEL BARS, BALLAST BOTTOM BARS, STANDARD 36" FLING WAND  
*FINIALS & EXTRA FLING WAND FOR CENTER OPENING DRAPES IS SOLD SEPARATELY.*

Track Width (Up To)	57" - 69"	91"	114"	132"	154"
No. of Panels	3	4	5	6	7
No. of Supports	3	3	3	5	5
Splice	0	0	1 splice (106"+)	1	1
Panel Overlap	7" - 1"	8" - 1"	6 1/2" - 1"	5 1/2" - 1"	5 1/2" - 1"
Stackback Width	26"	27"	28"	29"	30"

- NUMBER OF INCHES EACH PANEL OVERLAPS ONTO THE NEXT, VARIES ACCORDING TO TRACK LENGTH AND NUMBER OF PANELS.
- WIDTH OF ALL PANELS WHEN COMPLETELY STACKED TOGETHER.



# WAVE DRAPE • TEKNO WAVE, STANDARD WAVE, TEKNO SNAP & EXTENDED WAVE SYSTEMS

Wave Drape carriers use a new hook system as opposed to the traditional snaps.

- Wave Hooks allow for more flexibility and ease of use.
- Multiple fullness: 1.8 to 2.7 fullness.
- Easy installation, no force required to place hooks.
- Change hook placements quickly after drape is installed.
- Drapes can be washed even while hooks are installed.



WAVE TAPE

SNAP TAPE

## TAPE & CARRIERS



**HMP7080**  
WAVE TAPE  
*Hooks not included*



**HMP5060**  
STANDARD WAVE CARRIER  
*Hooks included*



**HMP5330**  
TEKNO WAVE CARRIER  
*Hooks included*



**HMP7070**  
SNAP TAPE



**HMP5200**  
STANDARD SNAP CARRIER  
*100% fullness*



**HMP5310**  
TEKNO SNAP CARRIER  
*100% fullness*

## OPTIONAL PRODUCTS



**HMP5180**  
STANDARD WAVE CARRIER 80%  
*Use to reduce stack back*  
*Hooks included*



**HMP5380**  
TEKNO WAVE CARRIER 80%  
*Use to reduce stack back*  
*Hooks included*



**HMP5090**  
TEKNO WAVE HOOK

**i** Extended Wave is only available with Tekno products.

An extended Wave with wider, shallow folds.  
ALLOWS SHOWCASING OF  
LARGE SCALE FABRIC PATTERNS & PRINTS.

EXTENDED WAVE USES A UNIQUE SYSTEM OF ACTIVE, INACTIVE CARRIERS, ELIMINATING UNPROFESSIONAL SPACER CORD SAGGING.

## EXTENDED WAVE

STANDARD WAVE



EXTENDED WAVE



## AVAILABILITY CHART

	EURO-SCOPE, TEKNO 25, TEKNO 40 WOOD, KONTUR ALU, URBAN 3 & 5		KONTUR EVO		TEKNO 40, NEXGEN, NEXGEN WOOD	
	Hand Draw	Corded	Hand Draw	Corded	Hand Draw	*Corded
Standard Wave Carrier	Y	Y	Y	N	Y	Y
Tekno Wave Carrier	Y	Y	N	N	Y	Y
Snap Carrier	Y	Y	Y	N	Y	Y
Tekno Snap Carrier	Y	Y	N	N	Y	Y
Extended Wave	Y	Y	N	N	N	N

\*NEXGEN CORDED TRACKS: MASTER CARRIERS WILL BE WITH A REGULAR FLAT OVERLAP.

## TEKNO CARRIERS

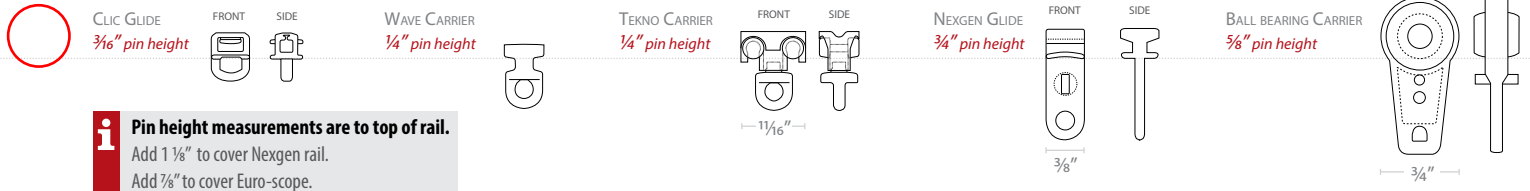

## EURO-SCOPE

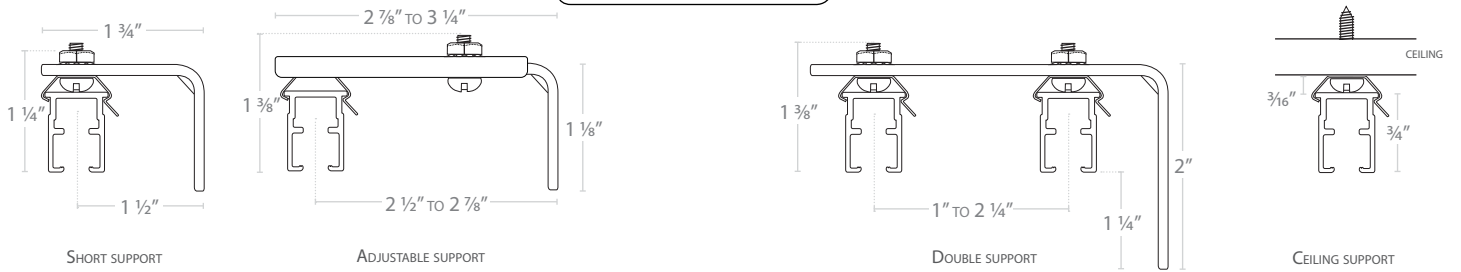

## TEKNO 25

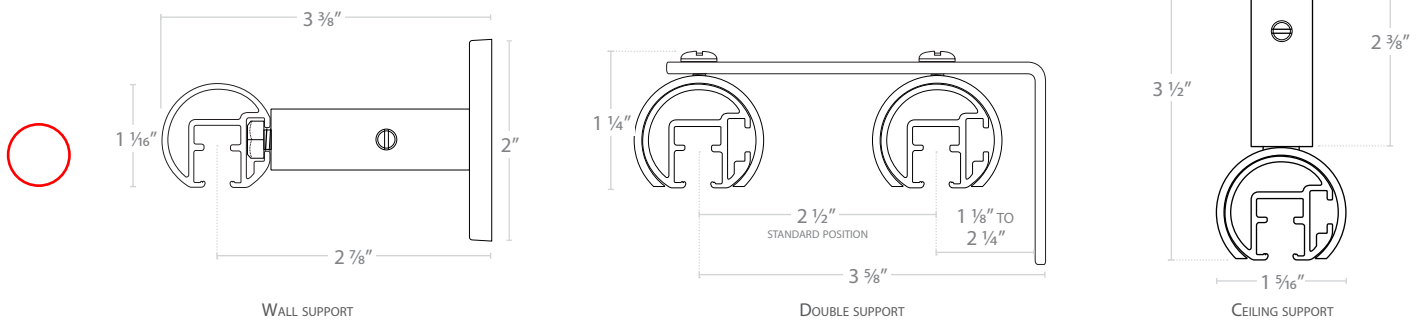

## KONTUR ALU & EVO

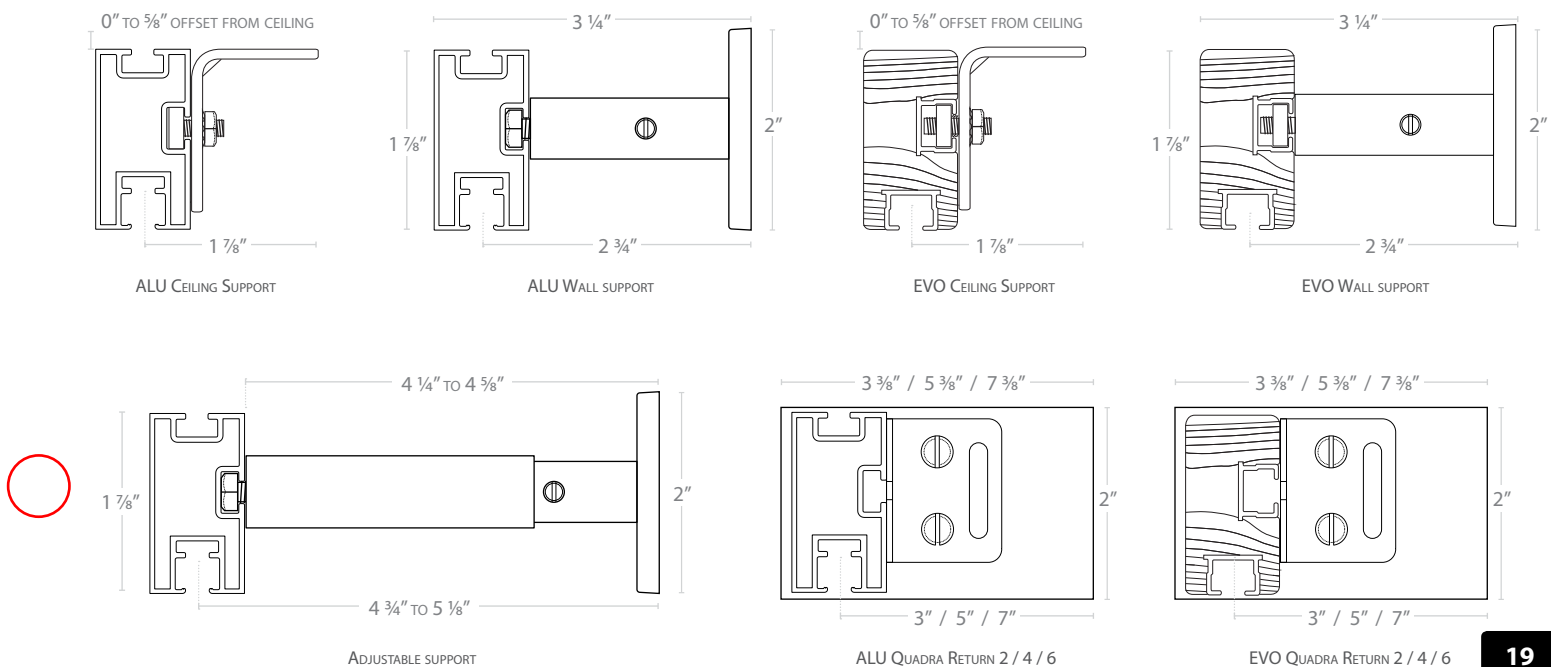

## URBAN 3 & 5

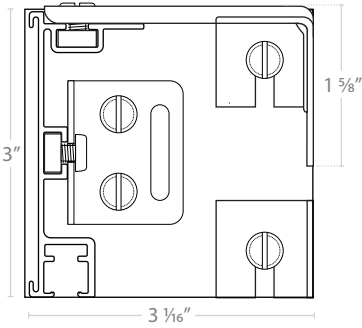

URBAN 3 RETURN 3  
*Showing all hardware*

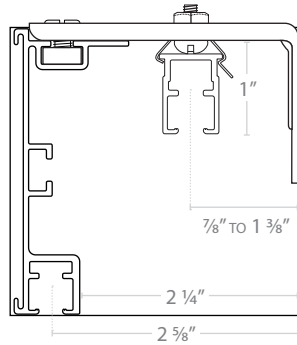

URBAN 3 RETURN 3  
*With Euro-Scope upgrade*

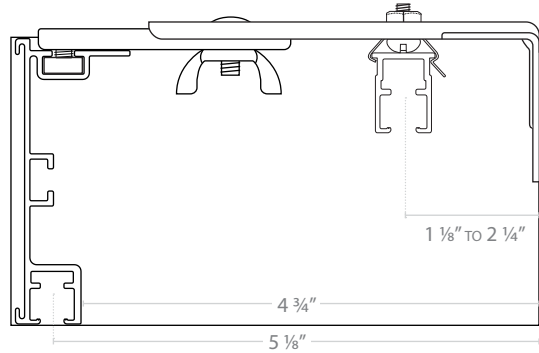

URBAN 3 - RETURN 5.5  
*With Euro-Scope upgrade*

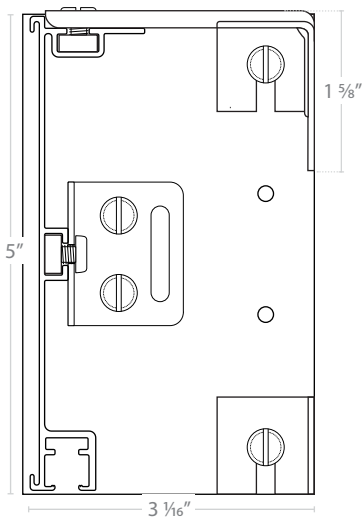

URBAN 5 RETURN 3  
*Showing all hardware*

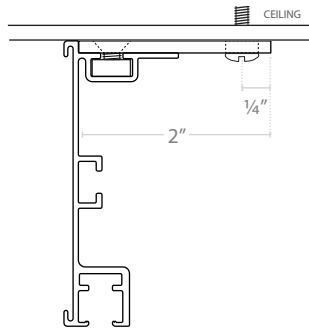

URBAN 3 CEILING SUPPORT

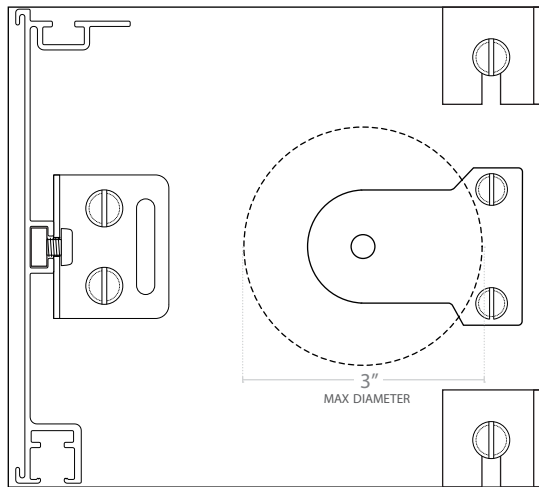

URBAN 5 - RETURN 5.5  
*Shade installation*

## TEKNO 40 WOOD

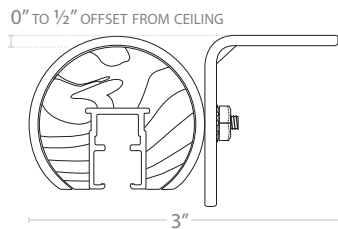

CEILING SUPPORT

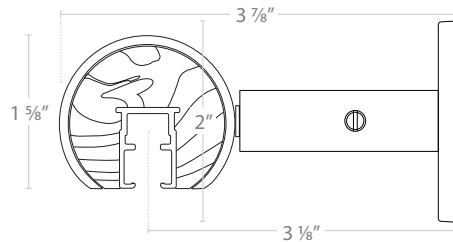

WALL SUPPORT

# TECHNICAL INFORMATION • TEKNO PRODUCTS

## NEXGEN

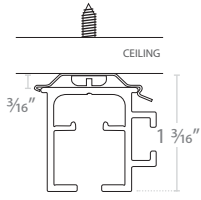

CEILING SUPPORT

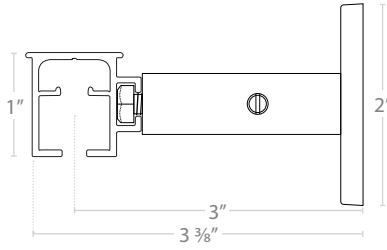

WALL SUPPORT

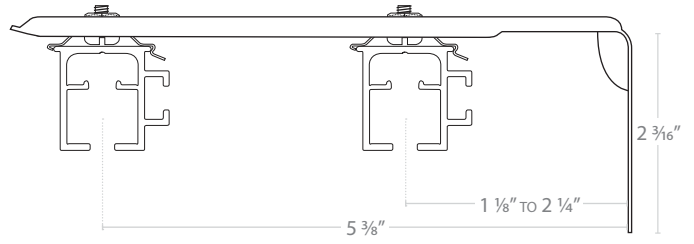

DOUBLE SUPPORT

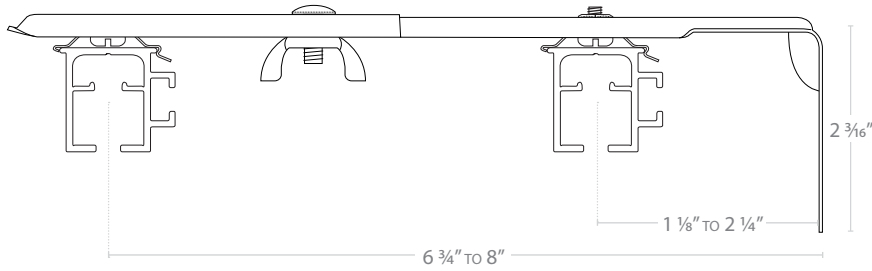

ADJUSTABLE DOUBLE SUPPORT

## TEKNO 40

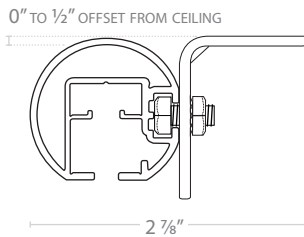

CEILING SUPPORT

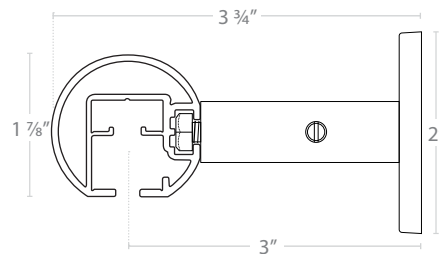

WALL SUPPORT

## NEXGEN WOOD

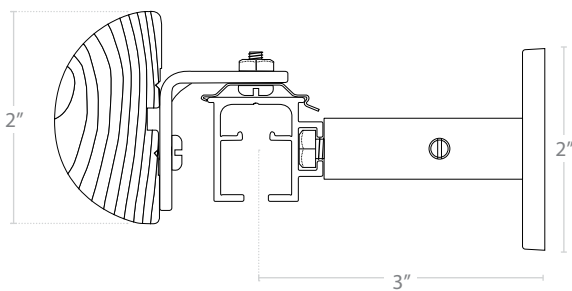

WALL SUPPORT

## EURO-SCOPE UPGRADE

**i** Make Back drape a minimum of 3/4" shorter than front drape.

Offset between Euro-Scope Upgrade & front rod.

KONTUR EVO & ALU	7/16"
NEXGEN	1/2"
NEXGEN WOOD	1/2"
TEKNO 25	1/2"
TEKNO 40	1/4"
TEKNO 40 WOOD	1/2"

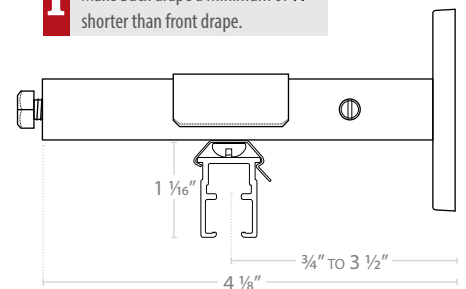

EURO-SCOPE INSTALLATION  
4" Support shown

# ARTFIL • THE ART OF SUSPENSION

ALL KITS COME WITH 10 FEET OF WIRE.  
THERE IS NO EXTRA CHARGE FOR WIRE LENGTHS UP TO 16 FEET (MUST BE REQUESTED).

AVAILABLE  
COLORS



**B**  
BRASS



**N**  
NICKEL

## OPTIONAL PRODUCTS



**HBP0450**  
CLASSIQUE CENTER SUPPORT



**HBP0350**  
BOLLA CENTER SUPPORT

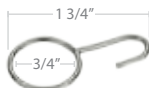

**HBP5400**  
S-HOOK



**HBP5280**  
RING WITH PINCH CLIP



## ARTFIL CLASSIQUE

### KIT EQUERRE - HBA9542

WALL OR CEILING INSTALLATION (CENTER SUPPORT NOT INCLUDED)

*Center support is required for lengths greater than 72"*

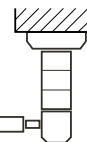
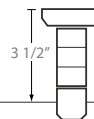
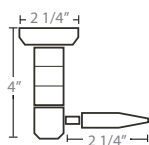

### KIT CONIQUE - HBA9543

INSIDE WALL MOUNT INSTALLATION

*Center support is required for lengths greater than 72"*

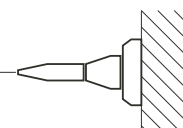
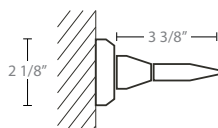

## ARTFIL BOLLA

### KIT EQUERRE BOLLA - HBA9433

WALL OR CEILING INSTALLATION (CENTER SUPPORT NOT INCLUDED)

*Center support is required for lengths greater than 72"*

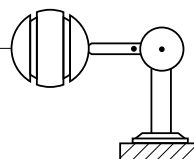
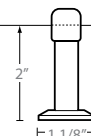
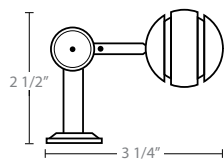

### KIT CONIQUE BOLLA - HBA9432

INSIDE WALL MOUNT INSTALLATION

*Center support is required for lengths greater than 72"*

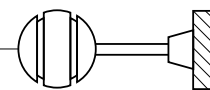
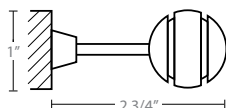

# RIVER ROCKS • 5/8" DIAMETER



**CONO**

HFP0017  
1 5/8" L X 1 1/4" DIA.  
Shown in Fossil



**KUGEL**

HFP0027  
1 1/4" L X 1 1/4" DIA.  
Shown in Russette



**RIALTO**

HFP0107  
1 1/2" L X 1 3/8" DIA.  
Shown in Antique



**TONIC**

HFP0097  
1 1/2" L X 1 3/8" DIA.  
Shown in Stainless



**TOSTANO**

HFP0087  
1 3/8" L X 5/8" H  
Shown in Stainless



**Available colors**  
Rods, finials & supports



**A**  
ANTIQUE



**F**  
FOSSIL



**RS**  
RUSSETTE



**S**  
STAINLESS

## RODS



**Rod measurement:** Measure for ROD LENGTH ONLY  
Maximum length for a single rod is 84".  
Rods greater than 84" will be shipped in 2 equal pieces.



HFTS3007  
STEEL TUBE

Above 72" length requires center support

ADJUSTABLE ROD KITS [SUPPORTS INCLUDED]



HAA1624 28" to 48"  
HAA1684 48" to 84"  
HAA1666 66" to 120"

## SUPPORTS



HFP6027  
EURO SUPPORT 2

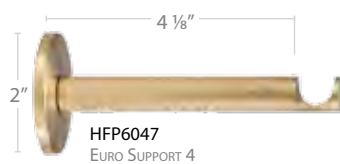

HFP6047  
EURO SUPPORT 4



HFP4027S - EXTENDER POST 2"  
HFP4047S - EXTENDER POST 4"  
Extends Euro Support



HFP6167  
EURO LATERAL SUPPORT

Inside mount -  
deduct 1/4" from rod per bracket.  
Use with ROD ONLY ensembles up to 72"



ADJUSTABLE SUPPORT 5/8" DIAMETER  
HFP6107 - SMALL 2 1/4" to 2 5/8"  
HFP6307 - MEDIUM 3 1/4" to 5"  
HFP6707 - LARGE 6 1/4" to 7 1/2"  
wall to pole

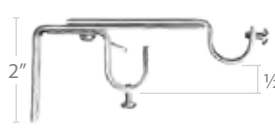

HAM1647  
DOUBLE COMBO SUPPORT  
Adj. projection - wall to pole  
Front rod - 3 1/2" to 5 1/4"  
Back rod - 1/4" to 2 3/8"



HFP6057  
THE COMPACT  
UNI-ARM 16  
1/2" projection, wall to pole.  
Ceiling or wall mount

## OPTIONAL PRODUCTS



HAP7707  
SAN FRANCISCO CORNER  
AVAILABLE COLORS: A, K, P, RS, S



3/4" DIAMETER  
HFP5207  
RING EURO 20  
Use with Ring Clip 48



1" DIAMETER  
HFP5347  
RING EURO 34  
Use with Ring Clip 48



HBP5480  
RING CLIP 48



1" DIAMETER  
HAA1625  
RING WITH EYELET  
Bag of 10



1" DIAMETER  
HAA1635  
RING WITH PINCH CLIP  
Bag of 10

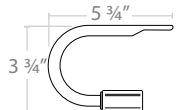

HFP4557  
UNI-ARM 16



Order finial and post separately.

## TIEBACKS



TONIC WITH 2" POST



RIALTO WITH 2" POST



TOSTANO WITH 4" POST



KUGEL WITH 2" POST



CONO WITH 2" POST

# SIMPLICITÉ • 1 1/8" DIAMETER



## AERONAUT

HAP0658

3 1/2" L x 2" DIA.

Shown in Chrome - Black - Chrome

\*Available colors:  
CKC, CSC, SCS



## CERAMIC BALL

HAP0688

3 3/8" L x 2 1/2" DIA.

Shown in Stainless

Available colors:  
CR, S



## DIGITAL

HAP0598

3" L x 1 3/8" DIA.

Shown in Stainless

Available colors:  
CR, DW, OB, S



## EMPIRE

HFP0548

7/8" L x 1 3/8" DIA.

Shown in Chrome

Available colors:  
CR, DW, OB, S



## GEMSTONE

HAP0588

4" L x 2 1/8" DIA.

Shown in Distressed Wood

Available colors:  
CR, DW, OB, S



## JOFFRE

HAP0608

4" L x 2 1/8" DIA.

Shown in Antique Silver

Available colors:  
AS, DW, OB



## LALIQUE

HAP0678

1 3/4" L x 3" DIA.

Shown in Oil Rubbed Bronze

Available colors:  
AS, DW, OB



## LINEA

HFP0568

3 3/8" L x 2" DIA.

Shown in Stainless

Available colors:  
CR, DW, OB, S



## MERCADO

HAP0668

2 5/8" L x 2 3/8" DIA.

Shown in Distressed Wood

Available colors:  
AS, DW, OB



## MUSKOKA

HAP0628

3 7/8" L x 2 5/8" DIA.

Shown in Oil Rubbed Bronze

Available colors:  
AS, DW, OB



## SILESTE

HAP0578

2 1/8" L x 2" DIA.

Shown in Chrome

Available colors:  
CR, S



## TAMA

HAP0638

3 5/8" L x 2 1/4" DIA.

Shown in Oil Rubbed Bronze

Available colors:  
AS, DW, OB



## TRANS LU

HFP0538

4" L x 2 1/8" DIA.

Shown in Stainless

Available colors:  
CR, DW, OB, S

## AVAILABLE COLORS



CR  
CHROME



DW  
DISTRESSED WOOD (BLACK)



OB  
OIL RUBBED BRONZE



S  
STAINLESS

## COLOR FOR CERTAIN FINIALS ONLY



AS  
ANTIQUÉ SILVER  
PAIRS WITH STAINLESS ROD

## \*AERONAUT COLOR CODES

CKC - CHROME, BLACK, CHROME  
CSC - CHROME, STAINLESS, CHROME  
SCS - STAINLESS, CHROME, STAINLESS

## RODDING

**i** Set Length - Factory will NOT cut rodding



STEEL TUBE

HATS3488 - 48"  
HATS3608 - 60"  
HATS3728 - 72"  
HATS3968 - 96"

## SUPPORTS

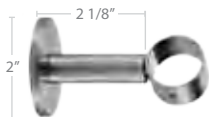

HFP6128

STAHL SUPPORT 2"



HFP6148

STAHL SUPPORT 4"

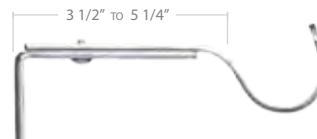

HAM6008

COMBO SUPPORT SELECT 28



HFP6168

LATERAL SUPPORT 28

Inside mount - deduct 1/4" from rod per bracket.  
Maximum length of rod is 72"

## OPTIONAL PRODUCTS



HAA5255

RING WITH EYELET  
Bag of 10



HFP5458

METRO RING  
Eyelet included

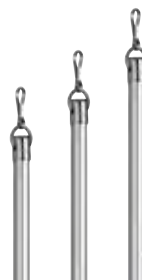

HMP7360 - 36"  
HMP7480 - 48"  
HMP7600 - 60"

ALUMINIUM FLING WANDS

AVAILABLE COLORS: BR, DA



HFP4468  
UNI-ARM 28



# ADJUSTABLE ROD KITS • 5/8" - 1/2" DIAMETER



ADRIA	ANTELOPE	BALL	CODA	LARGE BALL	RENAISSANCE	TORCH	TULIPE
HAA1609 3 7/8" L X 2" DIA. <i>Shown in Fossil</i>	HAA1626 4 1/2" L X 2 1/2" DIA. <i>Shown in Antique</i>	HAA1616 1 1/2" L X 1" DIA. <i>Shown in Stainless</i>	HAA1628 5 1/8" L X 2" DIA. <i>Shown in Desert</i>	HAA1606 2 3/4" L X 2" DIA. <i>Shown in Antique</i>	HAA1621 4 7/8" L X 2 1/2" DIA. <i>Shown in Pewter</i>	HAA1614 5 1/2" L X 2" DIA. <i>Shown in Russette</i>	HAA1622 2 7/8" L X 2" DIA. <i>Shown in Onyx</i>

Available colors  
Rods & finials

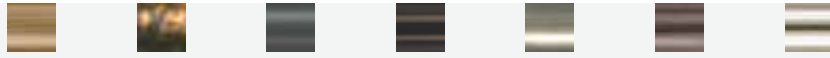

A ANTIQUE      D DESERT      F FOSSIL      K ONYX      P PEWTER      RS RUSSETTE      S STAINLESS

**i** Ensembles include:  
Adjustable rod, finials & regular Combo Supports

## KITS

*Doublette ensembles include:  
Back bracket & adjustable back rod.*

	ADRIA	ANTELOPE	BALL	CODA	LARGE BALL	RENAISSANCE	TORCH	TULIPE	DOUBLETTE	ROD KITS
Pair of finials	HAA1609	HAA1626	HAA1616	HAA1628	HAA1606	HAA1621	HAA1614	HAA1622	-	-
28" - 48"	HAA2409	HAA2267	HAA2416	HAA2287	HAA2406	HAA2421	HAA2414	HAA2422	HAA2400	HAA1624
48" - 84"	HAA8409	HAA8267	HAA8416	HAA8287	HAA8406	HAA8421	HAA8414	HAA8422	HAA8400	HAA1684
66" - 120"	HAA6609	HAA6267	HAA6616	HAA6287	HAA6606	HAA6621	HAA6614	HAA6622	HAA6600	HAA1666
Tieback ensemble	HAA4509	HAA4267	HAA4516	HAA4287	HAA4506	HAA4521	HAA4514	HAA4522	-	-

## SWING ARM



LENGTHS	ADRIA	ANTELOPE	BALL	CODA	LARGE BALL	RENAISSANCE	TORCH	TULIPE	NO FINIAL
14" - 22"	HAA5509	HAA5526	HAA5516	HAA5528	HAA5506	HAA5521	HAA5514	HAA5522	HAA5500
28" - 36"	HAA5609	HAA5626	HAA5616	HAA5628	HAA5606	HAA5621	HAA5614	HAA5622	HAA5600

## SAN FRANCISCO PROGRAM

**i** Ensembles include:  
(1) adjustable wall rod, (2) adjustable wing rods,  
(2) San Francisco Corners, (4) supports  
**(Finials Sold separately)**

**Available colors (CORNER COLOR / ROD COLOR)**  
ANTIQUÉ/DESERT, FOSSIL/ONYX, PEWTER/PEWTER  
RUSSETTE/RUSSETTE, STAINLESS/STAINLESS

CODE	WALL ROD	WING RODS
HAA2818	28" - 48"	18" - 32"
HAA2828	28" - 48"	28" - 48"
HAA4818	48" - 84"	18" - 32"
HAA4828	48" - 84"	28" - 48"
HAP7707	SAN FRANCISCO CORNER 5/8" DIAMETER	

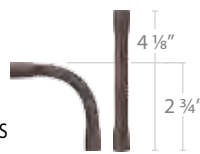

## CURVED ROD

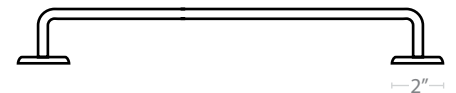

LENGTHS	28" - 48"	48" - 84"	66" - 120"
CODE	HAA7024	HAA7048	HAA7084

## OPTIONAL PRODUCTS & SUPPORTS



**HAM1647**  
DOUBLE COMBO SUPPORT  
*Adj. projection - wall to pole*  
Front rod - 3 1/2" to 5 1/4"  
Back rod - 1/4" to 2 5/8"



**HAM1600**  
COMBO SUPPORT  
*3 1/2" to 5 1/4" Adj. projection,  
wall to pole*



**HAM1641**  
SHORT COMBO SUPPORT  
*1 7/8" to 2 3/8" Adj. projection,  
wall to pole*



**HAM1643**  
LATERAL SUPPORT [PAIR]



**HAA1625**  
RING WITH EYELET  
*Bag of 10*



**HAA1635**  
RING WITH PINCH CLIP  
*Bag of 10*



**HAM1645**  
TIEBACK [PAIR]  
*Finials not included*

# ADJUSTABLE ROD KITS • 5/8" - 3/4" DIAMETER



**FLAIRISTE**

HAP0042  
3 1/8" L x 1 3/8" DIA.  
Shown in Distressed Wood  
Available colors: DW



**FLW 18**

HAP0032  
2 1/2" L x 2 1/4" DIA.  
Shown in Oil Rubbed Bronze  
Available colors: AS, DW, OB, RS



**IONIC 18**

HAP0012  
2 5/8" L x 2 1/4" DIA.  
Shown in Distressed Wood  
Available colors: AS, DW, OB, RS



**LUCINDA**

HAP0082  
3 3/8" L x 1" DIA.  
Shown in Chrome  
Available colors: CR



**NITRO**

HAP0052  
3" L x 1 1/4" DIA.  
Shown in Antique Silver  
Available colors: AS



**STYBAL 18**

HAP0022  
2 3/8" L x 2 3/8" DIA.  
Shown in Antique Silver  
Available colors: AS, DW, OB, RS

## AVAILABLE COLORS



## ADJUSTABLE ROD KITS

FINIALS	FLAIRISTE	FLW 18	IONIC 18	LUCINDA	NITRO	STYBAL 18	DOUBLETTE
28" - 48"	HAA2042	HAA2032	HAA2012	HAA2082	HAA2052	HAA2022	HAA2002
48" - 84"	HAA8042	HAA8032	HAA8012	HAA8082	HAA8052	HAA8022	HAA8002
60" - 108"	HAA6042	HAA6032	HAA6012	HAA6082	HAA6052	HAA6022	HAA6002

- ENSEMBLES INCLUDE: ADJUSTABLE ROD, FINIALS AND REGULAR COMBO SUPPORTS.
- DOUBLETTE ENSEMBLES INCLUDE: BACK BRACKETS AND ADJUSTABLE BACK ROD.

## SAN FRANCISCO PROGRAM

CODE	WALL ROD	WING RODS	COLOR	90° CORNER ANGLE	COLOR MATCHING TABLE
HAA2182	28" - 48"	18" - 32"	AS, DW, OB, RS		<b>ROD COLOR</b> ANTIQUE SILVER (AS) DISTRESSED WOOD (DW) OIL RUBBED BRONZE (OB) RUSSETTE (RSP)
HAA2282	28" - 48"	28" - 48"	AS, DW, OB, RS		
HAA4182	48" - 84"	18" - 32"	AS, DW, OB, RS		
HAA4282	48" - 84"	28" - 48"	AS, DW, OB, RS		
HFP7702	SAN FRANCISCO CORNER 3/4" DIA.		A, K, RS, S		<b>CORNER COLOR</b> STAINLESS (S) ONYX (K) ONYX (K) RUSSETTE (RS)

ENSEMBLES INCLUDE: (1) ADJUSTABLE WALL ROD, (2) ADJUSTABLE WING RODS, (2) SAN FRANCISCO CORNERS, (4) SUPPORTS  
**FINIALS NOT INCLUDED**

## OPTIONAL SUPPORTS

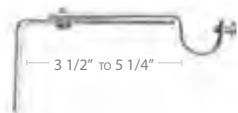

**HAM6002**  
COMBO SUPPORT SELECT 18  
Supports are included in ensembles,  
use for replacement parts only



**HFP6472**  
DOUBLE COMBO SUPPORT 18  
Adjustable projection from wall to pole  
Front rod - 3 1/2" to 5 1/4"  
Back rod - 1/4" to 2 5/8"



**HFP6102**  
SHORT COMBO SUPPORT 18  
Adjustable projection 1 7/8" to 2 3/8"  
from wall to pole

## OPTIONAL PRODUCTS



HMP7360 - 36"  
HMP7480 - 48"  
HMP7600 - 60"  
ALUMINIUM FLING WANDS

AVAILABLE COLORS: BR, DA



HAA5355  
RING WITH CLIP  
Bag of 10



HAA5255  
RING WITH EYELET  
Bag of 10



# WROUGHT IRON • 3/4" DIAMETER



## AVAILABLE COLORS

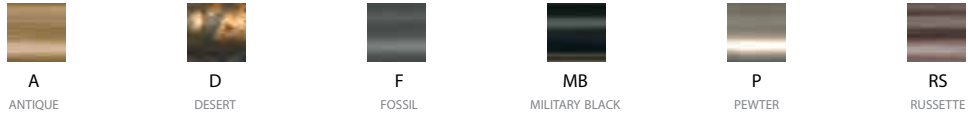

## RODDING



HFTS3002 - STEEL TUBE

- ALL MEASUREMENTS MUST BE FOR ROD LENGTH ONLY.
- MAXIMUM LENGTH FOR A SINGLE ROD IS 96".
- AFTER 84" A CENTER SUPPORT IS REQUIRED.
- RODS GREATER THAN 96" WILL BE SHIPPED IN 2 EQUAL PIECES.

## SUPPORTS



HFP6172

SCOPIC SUPPORT 6"

Use Infinette clips for double rod



HFP6142

SCOPIC SUPPORT 4"

Use Infinette clips for double rod

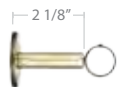

HFP6122

SCOPIC SUPPORT 2"



HFP6482

GORDIAN SUPPORT

Wall or ceiling mount



HFP6032

NIRVANA SUPPORT



HFP6432

STYLIZED COMBO 18



HFP6472

DOUBLE COMBO 18



HFP6462

ADJUSTABLE SUPPORT 18



HFP6162

LATERAL SUPPORT 18

Inside mount - deduct 1/4" from rod per bracket. Maximum length of rod is 72"



## OPTIONAL PRODUCTS



HFP7702

SAN FRANCISCO CORNER

3/4" diameter

AVAILABLE COLORS: A, K, P, RS



HFP5558

RING 55  
Use Ring Clip 56 (Sold separately)



HFP5262

STEEL RING  
Use Ring Clip 48 (Sold separately)  
Liner included



HFP5282

STEEL RING WITH EYELET  
Liner included



HBP5560

RING CLIP 56



HBP5480

RING CLIP 48



HMP7360 - 36"  
HMP7480 - 48"  
HMP7600 - 60"

ALUMINIUM FLUNG WANDS

AVAILABLE COLORS: BR, DA



HFP4460

NEWTON TIEBACK  
7" x 3 3/4"

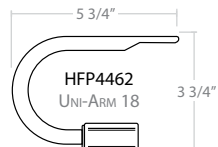

HFP4462

UNI-ARM 18



HFP7100 - 39"

FUSION FLUNG WAND

AVAILABLE COLORS: A, D, F, P, RS

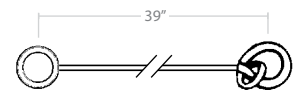

HFP7290

INTRA DRAPERY WAND

## INFINETTE CLIPS



HFP6712

REGULAR CLIP 3/4"  
Attaches 3/4" diameter rods to Scopic Supports



HFP6722

BUTTERFLY CLIP 3/4"  
Bridges 3/4" diameter rods to Scopic Supports



HFP6732

ALTERNATE CLIP  
Attaches an alternate rod to a Scopic Support



HFP6742

ALTERNATE BUTTERFLY CLIP  
Attaches an alternate rod to a Scopic Support

# WROUGHT IRON • 1" DIAMETER



**AVALON**

HFP0105  
7" L X 2 1/2" D  
Shown in Antique



**CAPUCHON 25**

HFP0185  
1" L X 1 3/8" D  
Shown in Russette



**FABRIXX**

HFP0485  
3 3/4" L X 2 1/4" D  
Shown in Antique



**FLAMME 25**

HFP0255  
4 1/4" L X 3" D  
Shown in Military Black



**GRAPPA**

HAP0335  
3 3/4" L X 2 1/4" D  
Shown in Antique



**PIPER**

HFP0235  
1 7/8" L X 1 3/4" D  
Shown in Pewter



**SEQUOIA**

HAP0425  
4 1/4" L X 1 3/4" D  
Shown in Russette



**TRINITY**

HFP0385  
2 1/2" L X 1 3/4" D  
Shown in Antique

## AVAILABLE COLORS



**A**  
ANTIQUE



**D**  
DESERT



**F**  
FOSSIL



**MB**  
MILITARY BLACK



**P**  
PEWTER



**RS**  
RUSSETTE

## RODDING



HFTS3005  
STEEL TUBE

HFTS3002  
STEEL TUBE

Use 3/4" ONLY FOR BACK RODS WITH INFINETTE CLIPS OR DOUBLE COMBO 25

- ALL MEASUREMENTS MUST BE FOR ROD LENGTH ONLY.
- MAXIMUM LENGTH FOR A SINGLE ROD IS 96".
- AFTER 84" A CENTER SUPPORT IS REQUIRED.
- RODS GREATER THAN 96" WILL BE SHIPPED IN 2 EQUAL PIECES.

## SUPPORTS



**HFP6175**

ELYPTIC SUPPORT 6"  
Use Infinette clips for double rod



**HFP6145**

ELYPTIC SUPPORT 4"  
Use Infinette clips for double rod

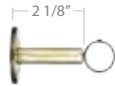

**HFP6125**

ELYPTIC SUPPORT 2"



**HFP6165**

LATERAL SUPPORT 25  
Inside mount -  
deduct 1/4" from rod per bracket.  
Maximum length of rod is 72"



**HFP6435**

STYLIZED COMBO 25



**HFP6475**

DOUBLE COMBO 25



**HFP6485**

AVALON SUPPORT  
Wall or ceiling mount



**HFP6035**

GINSA SUPPORT

## OPTIONAL PRODUCTS



HFP5558

RING 55  
Use Ring Clip 56  
(Sold separately)



HFP5262

STEEL RING  
Use Ring Clip 48  
(Sold separately)  
Liner included



HFP5282

STEEL RING WITH EYELET  
Liner included



ALUMINUM FLUNG WANDS

AVAILABLE COLORS: BR, DA

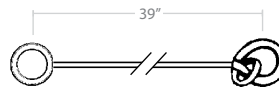

HFP7290

INTRA DRAPERY WAND



HFP7100 - 39"

FUSION FLUNG WAND

AVAILABLE COLORS: A, D, F, P, RS



HBP5560  
RING CLIP 56



HBP5480  
RING CLIP 48

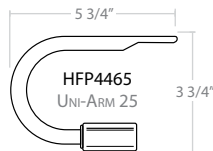

HFP4465

UNI-ARM 25



HFP4460

NEWTON TIEBACK  
7" x 3 3/4"

## INFINETTE CLIPS



**HFP6712**

REGULAR CLIP 3/4"  
Attaches 3/4" diameter rods  
to Elyptic Supports



**HFP6722**

BUTTERFLY CLIP 3/4"  
Bridges 3/4" diameter rods  
to Elyptic Supports



**HFP6732**

ALTERNATE CLIP  
Attaches an alternate rod  
to a Elyptic Support



**HFP6742**

ALTERNATE BUTTERFLY CLIP  
Attaches an alternate rod  
to a Elyptic Support

**i** Available colors for **finials** are identified in **RED TEXT**.

# METRO • 1 1/8" DIAMETER



**BALL 28**

HFP0048

3 3/8" L x 2 3/8" D  
Shown in Antique

**BARO 28**

HAP0328

4 1/4" L x 2 3/8" D  
Shown in Russette  
A, DW, RS

**EMPIRE**

HFP0548

7/8" L x 1 5/8" D  
Shown in Chrome

**EXCENTRIX**

HAP0318

4" L x 2 3/4" D  
Shown in Antique  
A, DW, RS

**LINEA**

HFP0568

4" L x 2" D  
Shown in Stainless

**OVAL 28**

HFP0468

2 1/8" L x 2 1/8" D  
Shown in Distressed Wood

**TRANS LU**

HFP0538

4" L x 2 1/8" D  
Shown in Stainless

## AVAILABLE COLORS



A

ANTIQUE



CR

CHROME



DW

DISTRESSED WOOD



RS

RUSSETTE



S

STAINLESS

## RODDING



HFTS3008  
STEEL TUBE

- ALL MEASUREMENTS MUST BE FOR ROD LENGTH ONLY.
- MAXIMUM LENGTH FOR A SINGLE ROD IS 96".
- AFTER 84" A CENTER SUPPORT IS REQUIRED.
- RODS GREATER THAN 96" WILL BE SHIPPED IN 2 EQUAL PIECES.

## SUPPORTS



HFP6128  
STAHL SUPPORT 2"



HFP6148  
STAHL SUPPORT 4"



HFP6178  
STAHL SUPPORT 6"



HFP6168  
LATERAL SUPPORT 28  
Inside mount -  
deduct 1/4" from rod per bracket.  
Maximum length of rod is 72"

## OPTIONAL PRODUCTS



HFP5458  
METRO RING  
Eyelet included

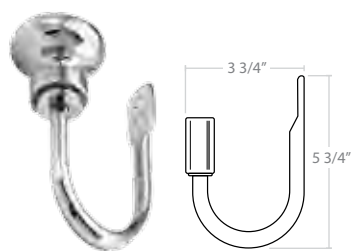

HFP4468  
UNI-ARM 28



HMP7360 - 36"  
HMP7480 - 48"  
HMP7600 - 60"  
ALUMINIUM FLING WANDS

AVAILABLE COLORS: BR, DA



## EURO-SCOPE DOUBLE ROD UPGRADE

**i** Ensembles include: rodding, clic glides, and all necessary mounting hardware.

AVAILABLE COLORS: BR, DA, F, W

SIZE UP TO	36"	48"	60"	72"	84"	96"	*108"	*120"	*132"	*144"	*156"
SPLICE	0	0	0	0	0	0	1	1	1	1	1
HAND DRAWN	HEH4030	HEH4040	HEH4050	HEH4060	HEH4070	HEH4080	HEH4090	HEH4100	HEH4110	HEH4120	HEH4130
ONE WAY	HEO4030	HEO4040	HEO4050	HEO4060	HEO4070	HEO4080	HEO4090	HEO4100	HEO4110	HEO4120	HEO4130
CENTER DRAW	HEC4030	HEC4040	HEC4050	HEC4060	HEC4070	HEC4080	HEC4090	HEC4100	HEC4110	HEC4120	HEC4130

\* RODS LONGER THAN 106" WILL BE SHIPPED IN TWO EQUAL PIECES TO AVOID HIGH TRANSPORT COSTS, BUT CAN BE ORDERED IN ONE PIECE WITH EXTRA SHIPPING AND HANDLING CHARGES.

PLEASE SPECIFY IF ONE PIECE IS REQUESTED.

**i** Available colors for **finials** are identified in **RED TEXT**.

# WROUGHT IRON • 1 1/2" DIAMETER



ACCENT	ARON	ELFIN	GARIBALDI	MELROSE	SINGULAR	TAMA 40	TAP
HFP0024	HTP0204	HTP0284	HTP0304	HTP0274	HFP0074	HTP0294	HFP0014
3 5/8" L x 2 1/2" D	4" L x 2 3/4" D	4" L x 2 3/4" D	3 3/4" L x 2 5/8" D	4 3/4" L x 3 1/8" D	6" L x 2 3/8" D	4 1/4" L x 2 7/8" D	1/2" L x 1 5/8" D
Shown in Russette A, D, F, P, RS	Shown in Distressed Wood AS, DW, MR	Shown in Maroon AS, DW, MR	Shown in Pewter A, F, P, RS	Shown in Antique Silver AS, DW, MR	Shown in Pewter A, D, F, P, RS	Shown in Distressed Wood AS, DW, MR	Shown in Antique A, D, F, P, RS

## AVAILABLE COLORS



## COLOR FOR CERTAIN FINIALS ONLY



## RODDING



HFTS3004  
STEEL TUBE

- ALL MEASUREMENTS MUST BE FOR ROD LENGTH ONLY.
- MAXIMUM LENGTH FOR A SINGLE ROD IS 96".
- AFTER 84" A CENTER SUPPORT IS REQUIRED.
- RODS GREATER THAN 96" WILL BE SHIPPED IN 2 EQUAL PIECES.

## SUPPORTS

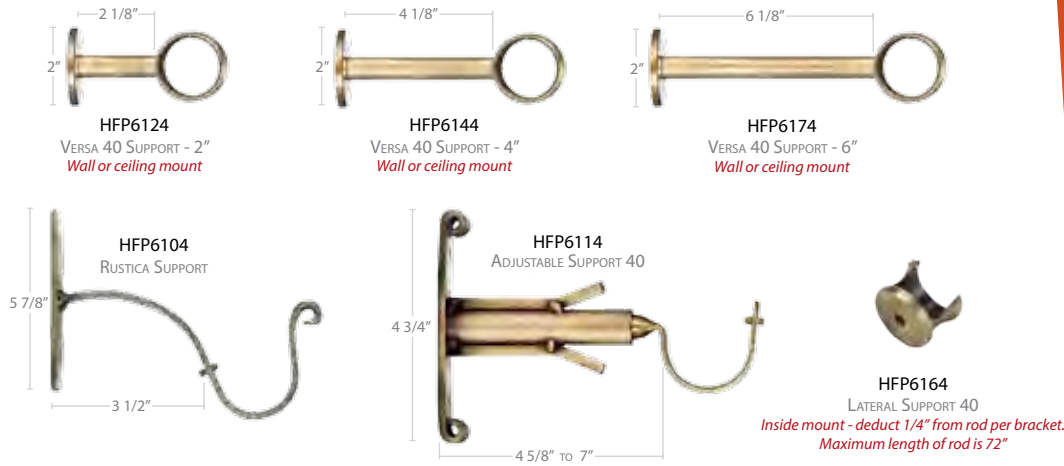

## OPTIONAL PRODUCTS

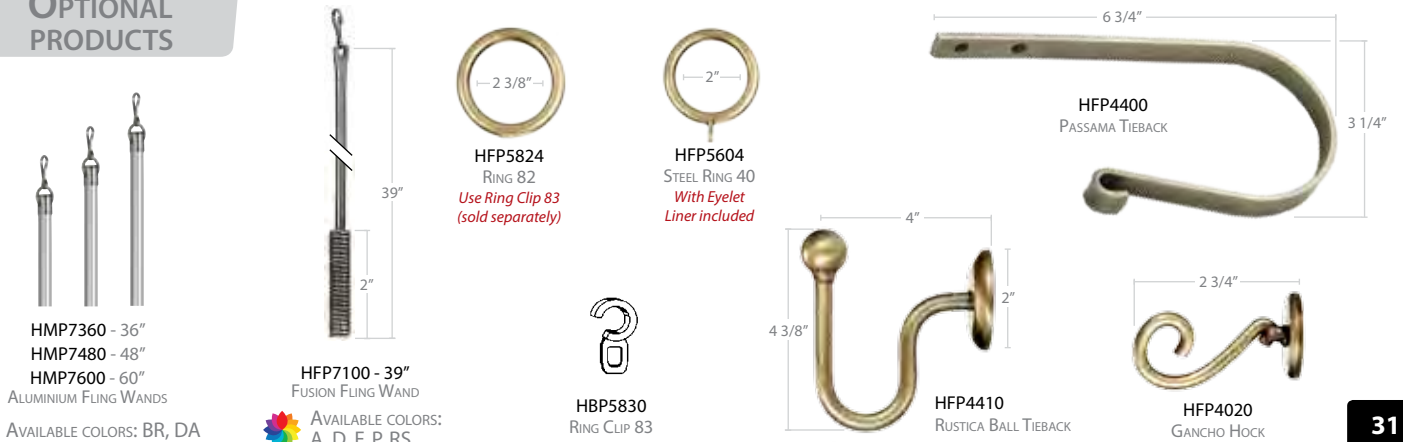

AVAILABLE COLORS: BR, DA

AVAILABLE COLORS:  
A, D, F, P, RS

# INFINETTE INSTALLATIONS



**BUTTON**

HBP0300  
Ø 7/8"



**CORD**

HFP0820  
Ø 2 1/2"



**STAR**

HFP0740  
Ø 2 7/8"



**FANETTE**

HFP0720  
Ø 2 3/4"



**FORBIN**

HFP0600  
Ø 3"



**FRANKI**

HFP0750  
Ø 2 3/4"



**GRAPPA**

HFP0620  
Ø 3 1/2"



**HORIZON**

HFP0860  
Ø 2 3/4"



**LILLIANE**

HFP0630  
Ø 3 1/2"



**LOUIS XVI**

HBP0390  
Ø 2 5/8"



**LOUIS XV**

HBP0310  
Ø 2 3/4"



**MANHATTAN**

HFP0610  
Ø 3"



**PETALINE**

HFP0640  
Ø 3 1/2"



**WAVES**

HFP0760  
Ø 2 3/4"

## AVAILABLE COLORS



**A**  
ANTIQUE



**D**  
DESERT



**F**  
FOSSIL



**P**  
PEWTER



**RS**  
RUSSETTE

## RODDING

HFTS3007  
STEEL TUBE - Ø 5/8"



Over 72" requires a center support

HFTS3002  
STEEL TUBE - Ø 3/4"



Over 84" requires a center support

HIA1328



ADJUSTABLE ROD KIT 28" to 48"  
Infinette Clips are included

HIA1348 48" to 84"  
HIA1366 66" to 120"



ADJUSTABLE ROD KIT  
Center support and  
Infinette Clips are included

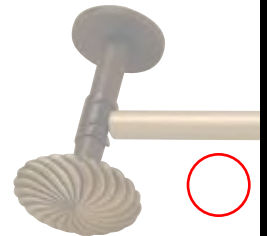

## SUPPORTS

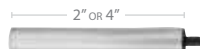

HFP4027 - 2"  
HFP4047 - 4"  
EXTENDER FOR POST COMPLETE

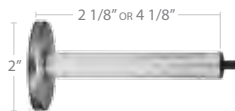

HFP4002 - 2"  
HFP4004 - 4"  
POST COMPLETE

SMALL: 1 7/8" to 2 3/8"  
MEDIUM: 3 1/2" to 5 1/4"  
LARGE: 6 1/4" to 7 1/2"



HFP6107 - 5/8" HFP6307 - 5/8" HFP6707 - 5/8"  
HFP6102 - 3/4" HFP6302 - 3/4" HFP6702 - 3/4"  
SUPPORT SMALL SUPPORT MEDIUM SUPPORT LARGE

Use as a center support instead of a medallion with post.



HFP6117 - 5/8"  
HFP6112 - 3/4"  
CRADLE  
Cradle used as a rod support with Post Complete



HFP6137 - 5/8"  
HFP6132 - 3/4"  
CLOSED CRADLE  
Closed Cradle is used as a rod support with Post Complete. Ideal for ceiling installations.



HFP6127 - 2"  
HFP6147 - 4"  
360° BRACKET WITH POST  
Use for lateral, ceiling or angled installations

## OPTIONAL PRODUCTS



HAP7707 - 5/8"  
HFP7702 - 3/4"  
SAN FRANCISCO CORNER



HFP5207  
RING EURO 20  
Use Ring Clip 48



HFP5347  
RING EURO 34  
Use Ring Clip 48



HFP5262  
STEEL RING  
Use Ring Clip 48 (Liner included)



HFP5282  
STEEL RING WITH EYELET  
Liner included



HFP7017 - 5/8"  
HFP7012 - 3/4"  
NYLON PLUG



HAA1635  
RING WITH CLIP  
Bag of 10



HBP5480  
RING CLIP 48



HAA1625  
RING WITH EYELET  
Bag of 10

## INFINETTE CLIPS



HFP6713 - 1/2"  
HFP6717 - 5/8"  
HFP6712 - 3/4"  
REGULAR CLIP  
Attaches rods to a Post Complete



HFP6723 - 1/2"  
HFP6727 - 5/8"  
HFP6722 - 3/4"  
BUTTERFLY CLIP  
Bridges rods to a Post Complete



HFP6732  
ALTERNATE CLIP  
Attaches an alternate rod to a Post Complete



HFP6742  
ALTERNATE BUTTERFLY CLIP  
Attaches an alternate rod to a Post Complete



# BRASS COLLECTION • 1" DIAMETER

## ENDCAP 25

**HBP0115**  
1" L X 1 1/8" D  
Shown in Brass  
Available colors: B, K, N

## REGENT

**HBP0015**  
1 7/8" L X 1 1/16" D  
Shown in Nickel  
Available colors: B, K, N

## BRAVA

**HBP0215**  
2" L X 3" D  
Shown in Brass  
Available colors: B, K, N

## FUEGO

**HBP0105**  
4 1/2" L X 2" D  
Shown in Brass  
Available colors: B, K, N

## CREATE YOUR FINIALS WITH PIECES IN BRASS, NICKEL OR ONYX!



### KOSMO

**HBA0415**  
1 7/8" L X 1 1/16" D  
Combination shown:  
Brass, Onyx, Brass (BKB)



### URBAN

**HBA0445**  
3" L X 1 5/8" D  
Combination shown:  
Nickel, Brass, Nickel (NBN)



### MASONIC

**HBA0505**  
2" L X 3" D  
Combination shown:  
Nickel, Onyx, Nickel, Onyx (NKNK)



### ESCALA

**HBA0405**  
3" L X 1 5/8" D  
Combination shown:  
Onyx, Brass (KB)

## AVAILABLE COLORS FOR BRASS PRODUCTS



## AVAILABLE COLORS FOR WOOD RODS



## RODDING



HBT3005 - BRASS TUBE



HBTW3005 - WOOD POLE

- ALL MEASUREMENTS MUST BE FOR ROD LENGTH ONLY.
- MAXIMUM LENGTH FOR A SINGLE ROD IS 96".
- AFTER 84" A CENTER SUPPORT IS REQUIRED.
- RODS GREATER THAN 96" WILL BE SHIPPED IN 2 EQUAL PIECES.

## SUPPORTS

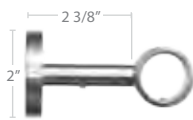

**HBP6205** — SUPPORT 2"  
**HBP6225** — CENTER SUPPORT 2"



**HBP6405** — SUPPORT 4 3/4"  
**HBP6425** — CENTER SUPPORT 4 3/4"

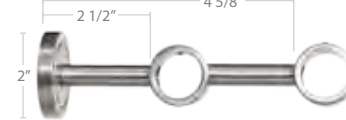

**HBP6505**  
DOUBLE SUPPORT



**HBP6605**  
STUDIO

Inside mount -  
deduct 3/16" from rod per bracket.  
Maximum length of rod is 72"

AVAILABLE COLORS: B, N

## OPTIONAL PRODUCTS



**HBP5558**  
RING 55  
Use Ring Clip 56  
(sold separately)



**HBP5560**  
RING CLIP 56



**HBP5478**  
CABLE RING  
Use Ring Clip 48  
(sold separately)



**HBP5480**  
RING CLIP 48



Available colors: B, N

**HBP4772** - 2"  
**HBP4774** - 3 3/8"  
**HBP4776** - 6"  
BRAVA HOOK



Available color: A

**HBP4782** - 2"  
**HBP4786** - 6"  
LIBERTY HOOK



Available color: A

**HBP4792** - 2"  
**HBP4794** - 4"  
**HBP4796** - 6 3/4"  
LOUIS HOOK



Available color: A

**HBP4751** - 1"  
**HBP4752** - 1 1/2"  
**HBP4754** - 2"  
TRADITIONAL HOOK

# BRASS COLLECTION • 1 1/8" DIAMETER



**ENDCAP 28**

HBP0208

1" L x 1 1/4" D  
Shown in Brass

Available colors: B, N



**BALBINA**

HBP0138

3 1/4" L x 2 3/8" D  
Shown in Brass

Available colors: B, N



**CHALICE**

HBP0238

2 1/2" L x 2 1/4" D  
Shown in Nickel

Available colors: B, N



**CALIENTE**

HBP0108

4 1/8" L x 2" D  
Shown in Brass

Available colors: B, N



**SHIITAKE**

HBP0098

2" L x 2 1/8" D  
Shown in Nickel

Available colors: B, N



**SYLO**

HBP0268

2 1/4" L x 2 1/4" D  
Shown in Nickel

Available colors: B, N



**CORONA**

HBP0058

4 1/2" L x 2 1/2" D  
Shown in Brass

Available colors: A, B



**LIBERTI**

HBP0158

4 1/2" L x 2 3/4" D  
Shown in Brass

Available colors: B



**LOUIS XVI**

HBP0048

3 3/4" L x 2 5/6" D  
Shown in Brass

Available colors: A, B



**RODOPLISSÉ**

HBP0068

3 1/8" L x 2 1/4" D  
Shown in Brass

Available colors: B



**SHERATON**

HBP0168

4 1/2" L x 2 1/2" D  
Shown in Brass

Available colors: B



**TORSADE**

HBP0188

2 3/4" L x 2 3/4" D  
Shown in Brass

Available colors: B

## AVAILABLE COLORS FOR BRASS PRODUCTS



**B**  
BRASS



**N**  
NICKEL

## COLOR FOR CERTAIN FINIALS ONLY



**A**  
ANTIQUE

## AVAILABLE COLORS FOR WOOD RODS



**CM**  
CHERRY



**WN**  
WALNUT

## RODDING



HBT3008 - BRASS TUBE



HBTW3008 - WOOD POLE

- ALL MEASUREMENTS MUST BE FOR ROD LENGTH ONLY.
- MAXIMUM LENGTH FOR A SINGLE ROD IS 96".
- AFTER 84" A CENTER SUPPORT IS REQUIRED.
- RODS GREATER THAN 96" WILL BE SHIPPED IN 2 EQUAL PIECES.

## SUPPORTS



HBP6308 — SUPPORT 3"  
HBP6328 — CENTER SUPPORT 3"



HBP6508 — SUPPORT 4 7/8"  
HBP6528 — CENTER SUPPORT 4 7/8"



HBP6808 — SUPPORT 7 1/4"  
HBP6818 — CENTER SUPPORT 7 1/4"



HBP6608  
STUDIO  
Inside mount - deduct 3/16" from rod per bracket.  
Maximum length of rod is 72"

## OPTIONAL PRODUCTS



HBP5558  
RING 55  
Use Ring Clip 56 (sold separately)



HBP5560  
RING CLIP 56



HBP5478  
CABLE RING  
Use Ring Clip 48 (sold separately)



HBP5480  
RING CLIP 48



Available colors: B, N

HBP4772 - 2"  
HBP4774 - 3 3/8"  
HBP4776 - 6"  
BRAVA HOOK



Available color: A

HBP4782 - 2"  
HBP4786 - 6"  
LIBERTI HOOK



Available color: A

HBP4792 - 2"  
HBP4794 - 4"  
HBP4796 - 6 3/4"  
LOUIS HOOK



Available color: A

HBP4751 - 1"  
HBP4752 - 1 1/2"  
HBP4754 - 2"  
TRADITIONAL HOOK

# BRASS COLLECTION • 1 1/2" DIAMETER



**BARTOLI**

HBP0134

3 3/8" L x 2 1/2" D

Shown in Brass

Available colors: B, N



**CALIX**

HBP0144

3" L x 2 1/4" D

Shown in Nickel

Available colors: B, N



**CORONET**

HBP0174

3 1/8" L x 2 1/4" D

Shown in Brass

Available colors: B



**FACETTE**

HBP0074

4 1/2" L x 2 1/2" D

Shown in Brass

Available colors: B



**LOUIS XV**

HBP0024

4 3/4" L x 2 3/4" D

Shown in Brass

Available colors: B



**SCEPTRE**

HBP0244

4 1/2" L x 2 1/2" D

Shown in Brass

Available colors: A, B

CREATE YOUR FINIALS WITH PIECES IN BRASS OR NICKEL!

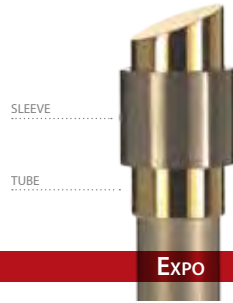

**Expo**

HBA0414

4" L x 2 1/8" D

Combination shown:

Tube in Brass, Sleeve in Nickel (BN)



**ESCALA II**

HBA0404

3 1/2" L x 2 1/8" D

Combination shown:

Sleeve in Nickel, Tube in Brass (NB)



**OLYMPIC**

HBA0424

3 1/2" L x 2 1/8" D

Combination shown:

Tube in Nickel, Rings in Brass (NB)

AVAILABLE COLORS



**B**

BRASS



**N**

NICKEL

COLOR FOR CERTAIN FINIALS ONLY



**A**

ANTIQUE

## RODDING



HBT3004 - BRASS TUBE

- ALL MEASUREMENTS MUST BE FOR ROD LENGTH ONLY.
- MAXIMUM LENGTH FOR A SINGLE ROD IS 96".
- AFTER 84" A CENTER SUPPORT IS REQUIRED.
- RODS GREATER THAN 96" WILL BE SHIPPED IN 2 EQUAL PIECES.

## SUPPORTS



HBP6274 — SUPPORT 5"

HBP6284 — CENTER SUPPORT 5"

## OPTIONAL PRODUCTS



HBP5824

RING 82

Use Ring Clip 83 (sold separately)



HBP5830

RING CLIP 83

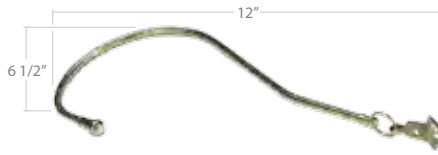

HBP4766

TUDOR TIEBACK  
Available color: B



HBP4764.AL (LEFT)

HBP4764.AR (RIGHT)

MEDICI TIEBACK  
Available color: A



HBP4772 - 2"  
HBP4774 - 3 3/8"  
HBP4776 - 6"  
BRAVA HOOK

Available colors: B, N



HBP4782 - 2"  
HBP4786 - 6"  
LIBERTY HOOK

Available color: A



HBP4792 - 2"  
HBP4794 - 4"  
HBP4796 - 6 3/4"  
LOUIS HOOK

Available color: A



HBP4751 - 1"  
HBP4752 - 1 1/2"  
HBP4754 - 2"  
TRADITIONAL HOOK

Available color: A



# County Draperies, Inc.

64 Genung St., Middletown, NY 10940

TEL 1.845.342.9009 FAX 1.845.342.1530 TOLL FREE 1.800.453.7273

[www.drape.com](http://www.drape.com) [quotes@drape.com](mailto:quotes@drape.com)